



**The Internet
of Things**

*A critique of
ambient technology
and the all-seeing
network of RFID*

ROB VAN KRANENBURG

Network ⁰²
Notebooks

The Internet of Things

***A critique of
ambient technology
and the all-seeing
network of RFID***

Report prepared by Rob van Kranenburg
for the Institute of Network Cultures
with contributions by Sean Dodson

Dedicated to Suzy Neuféglise, Roeliene van Wijk and Kitty de Preeuw and to my fellow travellers, especially Ben Russell, who was the first to help me map these new territories.

CONTENTS

Forward: A Tale of Two Cities	5
Foreword by Sean Dodson	
Chapter One: Ambient Intelligence and its Promises	10
The Inevitable Part of Ambient Intelligence	12
Chapter Two: Ambient Intelligence and its Catches	20
Chapter Three: Bricolabs	28
Jaromil on Piracy	31
False Things	34
The Reprap and the Bricophone	37
Case study: RepRap (by Sean Dodson)	38
Case study: Bricophone	40
No More Opposition?	41
Chapter Four: How to Act	46
Edges	47
Trust, Mistrust and Information	49
Adequate Response	51
Negotiability as a Strategy	54
References	56

COLOPHON

Network Notebooks editors: Geert Lovink and Sabine Niederer.

Copy editing: Sean Dodson.

Design: Studio Léon&Loes, Rotterdam <http://www.leon-loes.nl>.

Print: Telstar Media, Pijnacker.

Publisher: Insitute of Network Cultures, Amsterdam.

Supported by: Amsterdam School of Design and Communication, Interactive Media (Hogeschool van Amsterdam) and Waag Society, Amsterdam.

If you want to order copies please contact:

Institute of Network Cultures

HvA Interactieve media

Singelgrachtgebouw

Rhijnspoorplein 1

1091 GC Amsterdam

The Netherlands

<http://www.networkcultures.org>

info@networkcultures.org

t: +31 (0)20 59 51 866 - f: +31 (0)20 59 51 840

A pdf of this publication can be freely downloaded at:

<http://www.networkcultures.org/networknotebooks>

This publication is licensed under the Creative Commons

Attribution-Noncommercial-No Derivative Works 2.5 Netherlands License.

To view a copy of this license, visit

<http://creativecommons.org/licenses/by-nc-nd/2.5/>.

Amsterdam, September 2008.

ISBN/EAN 978-90-78146-06-3

Forward: A Tale of Two Cities

Sean Dodson

It was the best of times; it was the worst of times. A decade ago the science fiction author David Brin published the Transparent Society.¹ It was his tale of two cities, set 20 years in the future. Brin had a vision, or rather he had two. He had foreseen, more clearly than most, the coming ubiquity of a “surveillance society” and he posited two very polarised outcomes. Brin decided to pose the reader a straight choice: Which of these two outcomes do you want?

Brin told of two cities twenty years hence. From a distance both cities look very alike. Both, he said, would contain “dazzling technological marvels”, both would “suffer familiar urban quandaries of frustration and decay”. They would both be thoroughly modern; they would both be suffering from urban decay. They could be Rotterdam or Vancouver; Taipei or Istanbul. The precise location didn’t really matter. But what did matter would be that visitors to these future cities would notice something starkly similar about both: Street crime would be conspicuous by its absence. It would have all but vanished. Because peering down from “every lamppost, rooftop, and street sign”, tiny cameras “panning left and right” would stand sentinel over the future inhabitants of both our cities, “surveying traffic and pedestrians, observing everything in open view”.

But there the similarities ended. For City Number One – The City of Control – was a city of our nightmares, torn from the darker pages of Orwell’s 1984 and Zamyatin’s We. It is a place where “myriad cameras report their urban scenes straight to Police Central, where security officers use sophisticated image processors to scan for infractions against the public order – or perhaps against an established way of thought”. In this city of glass, Brin warned, citizens walk the streets aware that “any word or deed may be noted by agents of some mysterious bureau”.

But Brin also painted another city. This city would be as transparent as glass; here too the cameras remain, “perched on every vantage point”, but a subtle difference liberates these citizens from the aforementioned City of Control. Here the silent sentries do not signal straight back to the secret police, rather “each and every citizen of this metropolis can lift his or her wristwatch/TV and call up images from any camera in town. Here, a late-evening stroller checks to make sure no one lurks beyond the corner she is about to turn. Over there, a tardy young man dials to see if his dinner date still waits for him by the city hall fountain. A block away, an anxious parent scans the area and finds what way her child has wandered off. Over by the mall, a teenage shoplifter is taken into custody gingerly, with minute attention to ritual and rights, because the arresting officer knows the entire process is being scrutinized by untold numbers who watch intently, lest his neutral professionalism lapse”.

But that’s not the only difference in Brin’s tale of two cities. Privacy has also been better maintained and thought through. Micro-cameras (think cameraphones), so beloved by our citizens in public places are banned from many places indoors (but not inside police headquarters). This is a city built more on trust than control.

Brin’s future cities were very different; the beauty of the piece was that it presented a pair of contrasting ways of life representing “completely opposite relationships between

citizens and their civic guardians”.

A decade on from Brin’s vision which city do you think the world has chosen? The city of control or the city of trust? The answer, probably, is a bit of both. Both of Brin’s visions have entered the fabric of our daily lives in a decade where CCTV (closed-circuit television) and camera-phones became commonplace items: where each has become more prevalent in cities across the world. Indeed both visions of the future are doomed to failure as all such visions are. Like all prophetic works, they tell us more about the time they were written in than the time they attempt to predict. The world as ever moves on and even the most perceptive prophet cannot see what is around the corner.

But what if we were to reboot Brin’s vision for today, for 2008; to paint our visions of the city of control and the city of trust? What would we see? In our view of cities twenty years hence we see two cities that from a distance look very much alike. Both are thoroughly modern, both suffer urban decay, both are transparent as if made of quartz. But the thing that so disturbed Brin a decade ago – the ubiquity of cameras – is no longer the defining technology of our cities. Indeed, to a lesser or greater extent they could have even been rendered irrelevant by a range of succeeding and more sophisticated technologies.

In our future cities – twenty years hence - much subtler technologies now lay in their place. For instead of a nest of cameras atop each lamppost, lies a near invisible network of wireless frequencies where almost any object and space can be located and monitored, found and logged as easily as an item on eBay or the price of a flight on easyJet.

Our two cities are tied together like an “internet of things”. They are places where the urban infrastructure is embedded with a sophisticated network of traceable items. They are places where consumer goods are assigned IP addresses, just as web pages are today. And like Brin’s Transparent Society, our future cities of glass could go one of two ways.

So ask yourself, which one would you want? So let us consider the City of Control: It is a place where the deployment of radio frequency identification tags (RFID) have become not just commonplace but ubiquitous. Objects, spaces and, yes, even people are tagged and given a unique number, just like web addresses are today. Notions of public and private have begun to dissolve; or are rendered irrelevant; notions of property are rapidly being rethought. Security is the defining issue for those who can afford it, but also for those that cannot. Very soon, access to parts of the city is being carved off: allowing the rich and powerful entry where they please and the poor have access where they are lucky.

Every item you buy at the supermarket in the City Number One – the City of Control - is being tracked and potentially data-mined, lest there be a combination of goods in your basket that the authorities don’t like. Your movements are watched, not by the use of crude cameras (which it transpires were rather poor at fighting crime anyway) but by tags embedded in your gadgets or in your clothes or even under your skin. Transmitted wirelessly and instantly they connect with satellite systems that record your digital footprint endlessly. Every thing you buy, every person you meet, every move you make. They could be watching you.

City Number Two – the City of Trust – on the surface looks very similar to the City of Control. But here the citizens have been given much more control: Here pervasive systems have been embedded, but offered as an option rather than as a default. You leave your laptop on the train, no problem: with the ‘internet of Things’ can locate it on a search engine, even arrange for it to be delivered back to your door.

Similarly, just as in Brin’s future city the cameras were left on at the cop station, in

our City of Trust the movements of our Guardians are tracked where our citizens are free to switch there's off.

When Brin forecast his two cities he made a number of assumptions that have so far proved to be false. In both his cities he thought that the prevalence of cameras would cause street crime to vanish. They have not. But his predictions on the amount of extra cameras, both for surveillance and private use were incredibly prescient. Today we stand on a similar threshold; on the cusp of the so-called 'internet of things'. The deployment of RFID is only one form of ubiquitous computing, a term first coined by the late Mark Weiser in 1988 during his tenure as chief technologist of the Xerox Palo Alto Research Centre (Parc), that will see further deployment of information technology into our daily lives. For Weiser the future of information technology was as a utility, something that went on in the background like gas and electricity.²

The difference between Brin's vision and ours is the visibility of the tools of our future surveillance. Ubiquitous computing (often referred to as ubicomp) describes a set of processes where information technology has been thoroughly integrated into everyday objects and activities: to such an extent that the user is often oblivious to doing so.

Ubicomp isn't just part of our cities of the future. Its devices and services are already here. Think of the use of prepaid smart cards for use of public transport or the tags displayed in our cars to help regulate congestion charge pricing or the way in which corporations track and move goods around the world. These systems will expand geometrically over the next decade building the blocks for our future cities. The question is: what will we choose to build? A City of Control or a City of Trust?

The trouble is that so few of us are talking about these very new kinds of cities. There is no grand master-plan to look up, no city planners to consult nor architects to harangue. Our future cities are being designed in increments - an electronic toll here, a new supply chain there - and with little public knowledge, discussion or consent. With ubicomp already weaving its invisible thread into the fabric of our cities, the necessary debate over to what extent we allow it into our lives is needed: with utter urgency.

But how can we have this debate when already many of us are suffering anxiety fatigue from a long list of concerns over previous privacy issues?

The promise/threat of the "internet of things" promises to change both our cities and our relationships with one another. The way this internet of things interlinks the real world with the virtual has the potential to transform our cities more dramatically than even the introduction of the railway. But while the railway opened up our cities, bringing in new things like soap and foreign goods, the coming of ubicomp threatens to restrict our cities. To make them more closed, not open.

It is becoming increasingly clear that ubicomp is coming just as it was equally clear a decade ago that our cities were about to be furnished with a suites of surveillance cameras.

As Naomi Klein recently pointed out, the blueprints for the City of Control are already been acted out. Klein points us towards³ Shenzhen, one of China's emerging megacities. Thirty years ago Shenzhen didn't exist. It was just "a string of small fishing villages and collectively run rice paddies, a place of rutted dirt roads and traditional temples". But Shenzhen, thanks to its proximity to Hong Kong, was selected as the location for China's first "special economic zone" one of only four areas where capitalism would be permitted on an experimental basis.

"The result was a city of pure commerce, undiluted by history or rooted culture — the crack cocaine of capitalism. It was a force so addictive to investors that the Shenzhen

experiment quickly expanded, swallowing not just the surrounding Pearl River Delta, which now houses roughly 100,000 factories, but much of the rest of the country as well". Today, Shenzhen is a city of 12.4 million people, a massive industrial sprawl full of factories that make everything from iPods to laptops to sneakers to cars: "A still-under-construction super-light subway will soon connect it all at high speed; every car has multiple TV screens broadcasting over a Wi-Fi network. At night, the entire city lights up like a pimped-out Hummer, with each five-star hotel and office tower competing over who can put on the best light show".

But Klein has noticed something else about Shenzhen. She says it is "once again serving as a laboratory, a testing ground for the next phase of this vast social experiment". It is a vast network of some 200,000 surveillance cameras have been installed throughout the city. Most are in public spaces, disguised as lampposts. Soon the closed-circuit TV cameras will be connected to a "single, nationwide network, an all-seeing system that will be capable of tracking and identifying anyone who comes within its range... over the next three years, Chinese security executives predict they will install as many as two million CCTVs in Shenzhen, which would make it the most watched city in the world". It is almost precisely the vision foreseen by Brin a decade ago.

China's all-seeing eye is just one part of a much broader experiment in surveillance. China is also developing a project called "Golden Shield".⁴

"The end goal is to use the latest people-tracking technology — thoughtfully supplied by American giants like IBM, Honeywell and General Electric — to create an airtight consumer cocoon: a place where Visa cards, Adidas sneakers, China Mobile cellphones, McDonald's Happy Meals, Tsingtao beer and UPS delivery... can be enjoyed under the unblinking eye of the state, without the threat of democracy breaking out. With political unrest on the rise across China, the government hopes to use the surveillance shield to identify and counteract dissent before it explodes into a mass movement like the one that grabbed the world's attention at Tiananmen Square".

The point being that the technologies driving City of Control need not be restricted to China. This integration of cameras with the internet, cell phones, facial-recognition software and GPS monitoring that is being trialled with "Golden Shield" is to be extended across China and beyond. Systems that track our movements through national ID cards with RFID computer chips containing biometric information are being ordered around the world. As our systems that upload our images to police databases and linked to records of personal data. As Klein points out, "the most important element of all: linking all these tools together in a massive, searchable database of names, photos, residency information, work history and biometric data. When Golden Shield is finished, there will be a photo in those databases for every person in China: 1.3 billion faces".

Already the same Western corporations that have helped China to build its "Golden Shield" are lobbying Western Governments to build similar systems. The US already has plans to build "Operation Noble Shield", while similar city-wide projects similar to Shenzhen are being introduced in New York, Chicago and Washington DC. While London already has far more CCTV cameras than Shenzhen

In the preceding pages, Rob van Kranenburg will outline his vision of the future. He will tell of his early encounters with the kind of location-based technologies that will soon become commonplace and what they may mean for us all. He will explore the

emergence of the “internet of things”, tracing us through its origins in the mundane, back-end, world of the international supply chain to the domestic applications that already exist in an embryonic stage. He will also explain how the adoption of the technologies of the City Control is not inevitable, nor something that we must blindly accept nor sleepwalk into. In van Kranenburg’s account of the creation of the international network of Bricolabs, he will also suggest how each of us can help contribute to building technologies of trust and empower ourselves in the age of mass surveillance and ambient technologies.

So as Brin argued in the Transparent Society, that a greater common good could be established if surveillance is equal to all and if the public has the same access to those in power, so we argue that it would be good for society if the architecture of the “internet of things” is equal for all, and the public has the same tools as those in power.

REFERENCES

- 1 | David Brin, *The Transparent Society: Will Technology Force Us to Choose Between Privacy and Freedom?*, Cambridge, MA: Perseus Books, 1998.
- 2 | Mark Weiser, ‘The Computer for the Twenty-First Century’, *Scientific American* (September 1991), p. 94-10.
<http://www.ubiq.com/hypertext/weiser/SciAmDraft3.html>
- 3 | Naomi Klein, ‘China’s All-Seeing Eye’, *Rolling Stone* 1053 (May 2008).
http://www.rollingstone.com/politics/story/20797485/chinas_allseeing_eye
- 4 | Greg Walton, *China’s Golden Shield: Corporations and the Development of Surveillance Technology in the People’s Republic of China*, Montréal (Québec): Rights & Democracy, 2001.

1. Ambient Intelligence and its Promises

Rob van Kranenburg

“The most profound technologies are those that disappear. They weave themselves into the fabric of everyday life until they are indistinguishable from it”.

- Mark Weiser

The mist was skimming off the trees. You could not see the other end of Lake Jönköping in the early hours of a September morning. I was walking slowly on the running path enjoying the damp steam coming from the trees. The sun was rising, rays of light backscattering from hitting something in the middle of the lake. In a flash I saw King Arthur’s sword bursting from the perfectly calm water. It was at that precise moment that I experienced a sweet epiphany. It was very clear for a fraction of a second. I felt the scene was alive, and so was I. Progress has come to be defined as the ability to read data as data: the ability to read data as data and not noise.

In the last century, there was no way of reading information in the data drawn by the patterns of the seismographs. It was practically impossible to use seismology to accurately predict when an earthquake would strike. Vulcanologists could but read in particular ways that refused to turn data into reliable information. Until Bernard Chouet, a physicist – after five years of intensive study – saw patterns where no one had seen patterns before – decided what was data and what was not data. He focused on a particular pattern that no one had seen before. The design challenge we are facing now is similar: that of reading the flowing reality of our *surface*. How to store real-time information flows? How to chart them? Which are our seismographs? How do we match real-time processes with the signified that they are supposed to signify? How to find ways of deciding what is data and what is not data in the space of flows?

The ability to read data as data is what makes new beginnings. Reflect a while on what you bumped into, run up against, hit when you did not look. That mid-September in 2000 I was in Jönköping to visit the i3¹ Annual Conference, Jönköping *Building Tomorrow Today*. I was intrigued by this then, a symposium and network funded by IST (Information Society Technologies). I3 was about design, technology and people. I3, (pronounced eye-cubed) stood for Intelligent Information Interfaces, and aimed at developing new human-centered interfaces, aimed at a broad-base of the future population. The work was notable, not least, because it saw people as active participants, rather than passive recipients of information. Among the list of 20-odd projects was one entitled the Disappearing Computer (DC) which explored how you can support everyday life through ‘interacting artifacts’. The idea at that time was that these artifacts would form ‘new people-friendly environments’ in which the computer-as-we-know-it has no role.²

In the philosophy of Socrates there were three domains of knowledge with three corresponding states of knowing that were deigned equally important; Theoria, Techné and Praxis. Theoria with its domain of knowledge, episteme, was for the Greek gods; mortals could never reach this state of knowing. But they could try to strive for it. In Theoria (and episteme) we immediately recognise our concepts of theory and epistemology. In Techné with its domain of knowledge poësis we can retrieve the

concepts technology and poetry - related, for example, as follows: the poetics of Socrates can be seen as a catalogue of literary techniques. The original meaning of the word 'technology' is about daily know-how or method. It wasn't until the Great Exhibition of 1851 that technology became associated with machines. It is therefore all the more interesting that the domain of knowledge which belonged to Praxis: phronesis has dropped out completely, not only in our language but also in our thought and ways of thinking. Phronesis, that knowledge that any one of us uses daily in the practice of living an everyday existence, is no longer recognised as an important domain of knowledge with a modern linguistic equivalent.

For me this was one of the most important re-articulations that i3 promised, the attempt to recast - at another conceptual level - the three old Greek ways of knowing: an embodied knowing embedded in life and in 'virtual' life.

We have very little left of the work of Heraclite, just a few broken fragments. It took me five years to figure out, to grasp, - understand - allow me to let the word resonate for a moment - these lines of Heraclite: and I rephrase them in my own words - "of all that which is dispersed haphazardly, the order is most beautiful". In the *Fragments* you read that these lines are incomprehensible as far as the Heraclite scholars are concerned. In a footnote the editors explain that they can not link it as a line of verse with other words in other lines in verse. I read it and in reading I knew it to be true. But I could not explain why.

I went for a walk one day in the woods near Felenne, in the Belgian Ardennes. A beautiful walk it was, steep down, hued with the colours of autumn, leaves fading into black. In the quiet meadow that we passed I saw golden leaves, small twigs, pebbles sometimes - hurled into the most beautiful of patterns by the strength of water moving. I looked hard and realised there was indeed no other way of arranging them. I recognised leaves as data. In other words I had recognised data as data. And I recognised the inability to find a way to come to terms with Heraclite's line without walking, without taking a stroll in the woods and look around you, look around you and find the strength of streams arranging. The ability to read data as data is what makes new beginnings.³

In this I was not disappointed.

The research in intelligent information interfaces was, in the words of Dr. Norbert A. Streitz (PhD in physics, PhD in psychology), spearheading the metaphors and ways of thinking that we can focus on in laboratory research. One of his creations is i-LAND, a test bed for exploring how the world of everyday objects and places will be augmented with information processing, while at the same time exploiting the affordances of real objects in the real world. The disappearing computer would, according to Streitz, amounts to, or rather provides, (no not really even provides), but could to thought of as *genius loci*, - the spirit of the place.

What we see, I thought then, is a massive hegemonic move - in code through WYSIWYG (what you see is what you get) editors; in node through the disappearance of the author and style; in link through the disappearance of the image in the icon; in network through the disappearance of cable in mobile and satellite - towards the disappearance of the digital as tangible and visible technology, as *techné*. Is that a problem? Was not the pencil once technology - as it is still? The problem is not the move, neither the changing ways of seeing, neither the changing ways of use, the problem is the synchronization on all levels of a tendency to disappear into an on/off

metaphor as electricity has.

Electricity was the actual metaphor that the EU 1st project officer, Jakub Wechjert, used. He spoke of a vision of the future is one in which our everyday world of objects and places become 'infused' and 'augmented' with information processing. Computing, information processing, and computers disappear into the background, and take on the role more similar to that of electricity today - an invisible, pervasive medium distributed on or real world. In contrast, what will appear to people are new artifacts and augmented places that support and enhance activities in natural, simple and intuitive ways.

That, however, does not make it more unproblematic. For what we encounter in such an environment is the problematic and futile attempts to claim any which one – subject/ time/ space/ place – as an undisputed starting point for making meaning or sense, for deciding on how to act, for recalling how previous procedures operated, for projecting a sense of self into the future. In a mediated environment, it is no longer clear what is being mediated, and what mediates. Such environments - your kitchen, living room, our shopping malls, cobbled streets in old villages, are new beginnings as they reformulate our sense of ourselves in places in spaces in time. As new beginnings they begin new media.

I was dozing off in the big Conference Hall, thinking about all these new beginnings, this longing for new space to occupy as if it was the wild, Wild West. What worried me most were some rather satisfied minds. I too could visualise a setting in which people resonate with media through simulating processes. Simulating processes that are actual processes, for in a digitised real, any process might become experiential, might resonate. Then a speaker, I believe it was Streitz, came on stage. He spoke of a Bluetooth ring that whenever I walked in the woods could – if I so liked – enhance this walk for me (I wondered who needs to enhance a wood?) by activating a mechanism that would either reveal a screen near the tree or send information on a handheld computer. And on that screen I could read some more about that tree.

I was wide awake and I felt very strange. I looked around me, searching for any human presence in that lecture room; to wink at me, tell me it was all a big sick joke. I recalled my sword and King Arthur and my talking trees. No screens there. That was when I realized. I asked myself could some of what these people be talking about actually be dangerous? And the best thing I can do is stay close to them, track what they are interested in and either hack it or try to confuse the spaces in which they operate.

THE INEVITABLE PART OF AMBIENT INTELLIGENCE⁴

In *Dreams of a Final Theory*, Steven Weinberg speaks of the “spooky ability of mathematicians to anticipate structures that are relevant to the real world”. We all have the spooky ability to do just that, to anticipate structures that are relevant to the real world, however spooky the real world might become. For how hard it is to write about a world becoming strange, or new, or spooky, after the dotcom crash, after the high hopes of increasing productivity through IT, of readers and writers becoming “wreaders”, of liberty finally around the corner: a product to be played out in all kinds of gender, racial and cultural roles, a process to drive decision-making transparency in both offline and online processes.

Only to have woken up to the actual realisation of a highly synergized performance of search engines and back-end database driven visual interfaces. Postmodern theory, open source coding and multimedia channeling promised the production of a new, hybrid space: only to deliver the content convergence of many media channels. And yet,

we are in the process of witnessing the realisation of such a new space. In places where computational processes disappear into the background - into everyday objects - both my reality and me *as subject* become contested in concrete daily situations and activities. Buildings, cars, consumer products, and people become information spaces.

How difficult it is for us to grasp that Socrates in the Phaedrus speaks out harshly against writing, pencils and any other form of outsourcing our human memory to the environment, any kind of environment. How hard it is for us to see that that pen over there (do you still know what it looks like?) - once caused so much trouble? Actually, that is quite difficult. Anything we grow up with is not technology to us. It *simply is*. Moving as we are into the territory of Ambient intelligence (AmI), you see that we have between five years and a decade to make up our minds about what connectivities we really want as human beings on this planet.

After that these connectivities will disappear- as Mark Weiser so gently put it in his founding text ‘The Computer for the Twenty-First Century’⁵ into the “fabric of everyday life”. Weiser was the first – in 1992 – to realise we were riding around in a Rolls Royce, accessing the vast dreamlands of the internet through keyboards and the mouse. These computers had been conceived as early as 1964 when computers, like the CRAY 2, looked like giant machine rooms and consoles had eye-trackers and two round huge screens on wheels. That mouse is still around. Weiser suggested to take the chips, the sensors, the boards, the switches out of that piece of lone hardware and disperse it into the objects and the space surrounding us; as smart textiles into clothes/wearables, as smart materials into walls, floors, buildings, as smart objects into a vast virtual realm, logistics heaven.

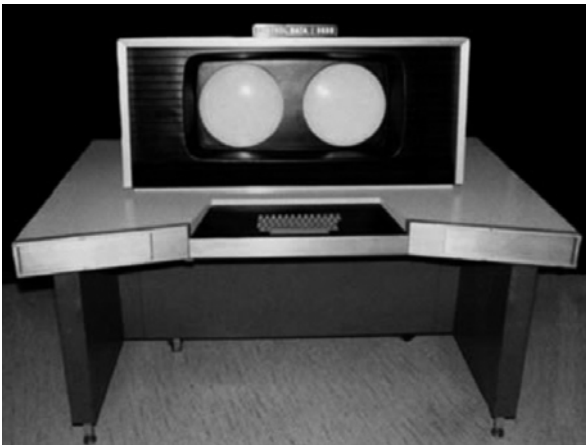
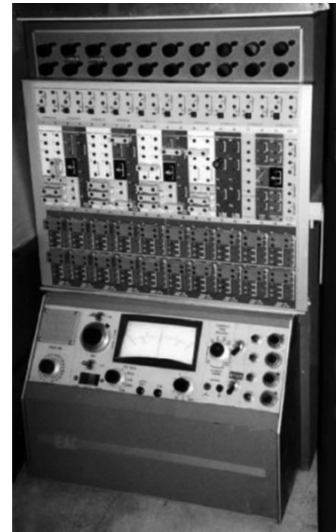

FIGURE 1 | NOT SO INVISIBLE COMPUTING: A 6600 SUPERCOMPUTER CONSOLE FROM 1964.

IT IS 1964 AND THIS IS THE ORIGINAL CONTROL CONSOLE FOR THE FIRST SUPERCOMPUTER, THE CDC 6600. MANUFACTURED BY THE CONTROL DATA CORPORATION. SERIAL NUMBER: 0002. DESIGNER: SEYMOUR CRAY. IT LOOKED LIKE THIS:



YOUR AVERAGE ANALOGUE COMPUTER IN 1964 WOULD LOOK LIKE THIS:



NOW IN 1964 THERE WAS A MOUSE:



THIS IS A DRAWING FROM ENGBART'S PATENT:

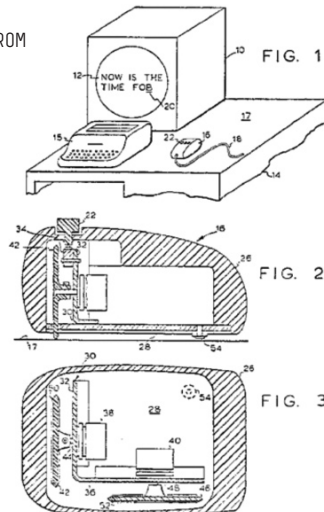

And it looked like that. Do you recognise it? Yes. It is the only thing that we recognise. It is the only thing that has not changed. It is the interface. From 1964 to 2004 all energy went to distributing system architecture, and centralising system infrastructure. Money was spent on creating standards, the desktop PC, the laptop, batteries. Internet access through copper, fibre was widely made available. From 1964 to 2004 all energy went to cutting down processor size, and speeding up processor power. Forty years well spent. But can we afford such one-sided innovation when it comes to the merging of the analogue and digital in everyday situations? Clearly not. In the real world interface is as essential as infrastructure and architecture when it comes to connectivity with people and things.

We are entering a land where the environment has become the interface. We must learn anew how to make sense. Making sense is the ability to read data as data and not noise. A matter of life and death when dealing with the flowing reality of the earth's core: "If we consider that the oceanic crust on which the continents are embedded is constantly being created and destroyed (by solidification and re-melting) and that even continental crust is under constant erosion so that its materials are recycled into the ocean, the rocks and mountains that define the most stable and durable traits of our reality would merely represent a local slowing down of this flowing reality".⁶

Reading this local slowing down of flowing reality has never been easy, in fact it has never been possible. The challenge we are facing now is reading the flowing reality of our surface when the environment is increasingly the interface.

When Cook's 'Endeavour' sailed into the bay that we know now as Cape Everard on April 22, 1770, touching upon Australian shore for the first time, the British saw Aborigines fishing in small canoes. Whereas the native population of Tahiti had responded with loud chanting and the Maori had thrown stones, the Aborigines, neither afraid nor curious, simply went on fishing. Only until Cook had lowered a small boat and a small party rowed to the shore did the Aborigines react. A number of men rowing a small boat signified a raid and they responded accordingly. The Aborigines must have seen something and even if they could not see it as a ship, they must have felt the waves it produced in their canoes. However, as its form and height was so alien, so contrary to anything they had ever observed or produced, they chose to ignore it since they had no adequate procedures of response. In Dreamtime, the Aborigines believed they saw an island. And as islands are common, you can let them drift by, you don't notice them, you don't perceive them as data. They thought Cook's boat was an island. When you see an island you do not have to look up.

It will pass.

We find ourselves today in a similar situation. On our horizon is a leviathan as unknown and dangerous as the British were to the Australian aborigines. Our Endeavour is the merging of digital and analogue connectivity as described by Mark Weiser and Eberhardt's and Gershenfeld's announcement in February 1999 that the Radio Frequency Identification (RFID) tag had dropped under the price of a penny.

For most common users the ubiquitous computing revolution is too fundamental to be perceived at such. Some professional users believe in smooth transitions. Tesco's UK IT director, Colin Cobain, says that RFID tags will be used on 'lots of products' within five years - and perhaps sooner for higher value goods; "RFID will help us understand more about our products", he claims. And some professionals believe "that what we call

ubiquitous computing will gradually emerge as the dominant mode of computer access over the next twenty years. Intriguingly, it is Mark Weiser who believed “that ubiquitous computing will enable nothing fundamentally new, but by making everything faster and easier to do, with less strain and mental gymnastics; it will transform what is apparently possible”.

Contrary to Mark Weiser’s claim that ubiquitous computing will enable nothing fundamentally new, I believe that ubiquitous computing will enable something fundamentally new, and the main question is: to what extent does it allow for human agency?

Wireless is increasingly pulling in all kinds of applications, platforms, services and objects (RFID) into networks. Many people communicate through mobiles, Blackberries, digital organisers and palmtops. Cars have become information spaces with navigational systems, and consoles, like Nintendo DS and Sony PSP, have wireless capabilities and Linux kernels installed. We are witnessing a move towards pervasive computing as technology vanishes into intelligent clothing⁷ and wearables,⁸ smart environments (which know where and who we are) and pervasive games.⁹ We will see doors opening for some and closing for others. Mimicry and camouflage will become part of application design. iPods will display colours and produce sounds that correspond to your surroundings. Eventually they will come with a “kill switch” that, for example, that will automatically lower the volume when you are on a train. Mobiles will react to their environment too, shutting themselves off when they detect that they are in a restaurant.¹⁰

Artists have always exploited the conditions for technological change, applications and services. In the move towards ambient - from the internet to the ‘internet of things’ - the poetic process of making meaning and creating experiences is no longer only productive on the level of design, but it lies at the heart of the IT architecture of the system, its standards and protocols. Distributing security – which is the key to digital systems that are focused on control – will in an ambient environment halt innovation, emerging uses and services and launch and learn scenarios. *Resonance* not interaction is the design principle in environments where connectivity is everywhere yet not always accessible to individual users. How to design resonance? How to employ distributing insecurity as a system principle? Where is your control as a programmer, as a systems architect in such a situation?

RFID technology is at a crucial point, in terms of standards and policies, regulations and deployment and services. As technology becomes ever more deeply embedded in everyday life and the experienced economies, it can no longer see design as a front-end tool, nor as a social and cultural issues as a sphere that has to mold itself around new technologies. On the contrary, as we see so clearly with RFID one has to hardcode these issues into the systems architecture and see them not as problems, not as drawbacks but as challenges to overcome at all levels of a successful introduction of new technologies.

We need to move to debate further from this seemingly deadlocked polarised state it appears we are at now. Distributing yourself as data into the environment has been the revolving wheel of progress for our conceptions and applications of technology. Location-based, real-time – services, applications to strengthen communities, and the capacity to generate high quality data in information overload, these are all possibilities within a wired connected environment that need serious exploration and research.

There are four levels of requirement for a successful introduction of new technologies:

code, node, link, and network. The *code node link network* framework helps to structure thinking on emergent technologies. *Code* refers to the axioms underlying the technology, how does it function and why. Marc Langbeinrich thought: “You get real world privacy guidelines from direct feedback from developers”. However, he found very little thoughts on privacy at all from developers. On the code level, privacy is seen as a layer that can be added, not as a factor in the coding process. His proposal was to make simple direct surveys to tick off a code against privacy issues, and a generic privacy toolbox. *Node* refers to the new data and information structures that are generated by the technology, for example new languages such as PML (Physical Markup Language). *Link* refers to the technological and application and services context that the new technology is affecting. *Network* refers to the broader cultural, social and political issues that are raised by the new technology.

RFID fits the bill on all levels. It is a relatively cheap answer on all levels.

CODE In the dominant paradigm, computing needs to be distributed, non-central. As RFID is pull technology, the RFID reader emitting energy so that the passive tag gives its unique number (says hello, here I am) the EPC Global network layout makes it possible to track a bottle in your room (provided there is a reader in your door, floor, building) through a simple web query by typing the unique ID number (available through retail channels) as the ID of the bottle is logged into the local database (your computer, work server, office building network) which is hooked up to the EPC Global network. In this database through an RFID scripting language called Savant, the item’s log is sent to an Object Name Server (ONS) where it can be accessed via the web, for example from Tokyo. It is very difficult for a system to get so global, local, real-time and easy accessible.

NODE In a digital environment there is only scripted scarcity. Servers now hold the capacity to log, store and track vast amounts of data generated by formerly lone objects. In the logistics need to individuate, RFID is regarded as a smart barcode.

LINK The merging of analogue and digital connectivity has many guises - from Ambient intelligence to pervasive computing. This way of looking at computing – from design to infrastructure, from concept to prototype – has no competition at the moment. It is a global, all encompassing framework to reflect on and design towards more digital connectivity. In the EU vision, the concept of Digital Territory is an ambient layer of connectivity over Europe in order to deliver real-time services to citizens. RFID is seen as the glue to this wireless spectrum.

NETWORK A policy directed towards more control, security, safety, non-risk directed. In 2006 a heated debate was sparked by the US decision to embed RFID chips into passports.¹¹ Some people sketched the scenario of a terrorist on a foreign airport using an RFID reader to scan for US citizens. RFID, however, is being embedded in passports, bankcards, credit cards, Chinese ID ‘smart’ cards, classified documents, employee access cards, travel passes, and other kinds of identification that identifies human beings by unique numbers. In the current ‘War or Terrorism’ RFID, because of its ease of distribution, low cost, technological simplicity, - although insecure – is a logical candidate for bottom-up tracking and tracing of things and the ways in which things move around; in boats, in trucks, in planes, in hands (of human beings).

So what would you do if you oppose RFID? It is impossible to provide an alternative to RFID that operates on all levels? Yes, 3D barcodes can replace RFID at item level, as

they are made up of layers of color and can hold up to 1.8 MB of data you can scan with software on your mobile phone. Yet 3D barcodes cannot be the glue to the Internet of Things, nor can they – because of their visibility – be used as a layer of surveillance. Yes, Global Positioning Systems (GPS) can do a lot in terms of tracking, Bluetooth provides a performance range, Zigbee -low-cost, low-power, wireless mesh networking standard - delivers battery powered predefined nodes with assigned functions (for example a home security network), but at item level it is way more expensive than RFID tags that draw their energy to say ‘Hi’ from the reader.

In 2009, you will no longer hear of RFID. The word will be either smart card, M2M (Machine 2Machine), or NFC (Near Field Communication). In April 2008 Nokia ordered 300 million NFC chips at Moversa (NXP/Sony), to promote mobile payment.¹²

Susanne Ackers from Hartware MedienKunstVerein, Dortmund, describes how McLuhan saw satellite communication systems both as an extension of the human nervous system and as a point of no return. The satellite infrastructure creates connectivity from above. The RFID infrastructure creates connectivity from below. Once you could say: “And we are in the middle”. Currently, however, there is no more *we* as in *we* human beings, the “*we*” is an information space like any other. So who or what is going to do the interpreting of all these data? That is the key question. Three observations caused this question to be noticed as a question:

THERE IS NO MORE PUBLIC, ONLY AUDIENCE. Putting technological issues on an agenda for a ‘general’ audience requires either a thousand interfaces (for a thousand different audiences) or a scandal.

THERE IS NO FORGETTING, NO MEMORY LOSS IN DIGITAL TERRITORY. A world where a layer of digital connectivity has been programmed on all things analogue. Consequently you should not say: “I’m not doing anything wrong, so why should I worry about smart cameras with 3D coordinates reading my face, or this RFID/M2M/NFC infrastructure? No, you should worry about whom will deem what wrong in three years from now, as from the moment of going live all movement will irrespective of man, machine or animal) be logged, stored and data mined. The data mining algorithms are not open source, transparency is limited and there is no talking back feature. Who knows, you may even get in trouble for reading this book. In the analogue days we could get away with claiming ‘Hmm, I’m not sure where I’ve picked that up...’” In Digital Territory this is no longer possible.

THERE ARE NO MORE HUMANS, ONLY INFORMATION SPACES. At a particular moment from a database point of view, you will have more in common with your car than with your neighbour. For some idiot savants a green toothbrush is terribly different from a red toothbrush, a very different thing altogether...

Unless we find new ways of scripting new forms of solidarities with digital technology, it seems like we can envisage two roads that both lead to less dialogue, less communication, less innovation, less business opportunities, less sustainable options. The one focuses on control in a fundamentally flux wireless environment. The other focuses on hiding the technological complexity behind ever more simple user friendly interfaces. In both cases there is no learning by citizens on how to function within such a system, thereby, opening up all kinds of breakdown scenarios.

In *A Future World of Supersenses*, Martin Rantzer of Ericsson Foresight claims: “New communication senses will be needed in the future to enable people to absorb the enormous mass of information with which they are confronted”. According to him the user interfaces we use today to transmit information to our brains threaten to create a real bottleneck for new broadband services. The bottleneck is thus our embodied brain, not our capacity to boost cable or wireless connectivity. The design challenge in implementing digital connectivity in an analogue environment lies in creating a working concept of corporal literacy that will inform a design for all the senses.

In a ubiquitous computing environment the new intelligence is extelligence, “knowledge and tools that are outside people’s heads”. When computational processes disappear, the environment becomes the interface. In such an environment - where the computer has disappeared as visible technology - and human beings have become designable and designerly information spaces - design decisions inevitably become process decisions. Are our current designers, architects, policy makers equipped to deal with these fundamental issues and dilemma’s, where what used to be media ethics has now become building ethics itself?

2. Ambient Intelligence and its Catches

FROM: KMA@SPYCHIPS.COM
SUBJECT: RE: CRUCIAL STAGE
DATE: SAT 7 APR 2007 15:17:22 GMT+02:00
TO: KRANENBU@XS4ALL.NL

YOU GUYS BLEW IT IN EUROPE BY NOT STAGING ACTUAL PROTESTS, IN MY HUMBLE OPINION. THAT'S THE ONLY WAY TO GET BUSINESSES TO LISTEN. TIME SPENT IN BRUSSELS IS A TOTAL WASTE, JUST AS TIME SPEND IN WASHINGTON, DC IS A TOTAL WASTE. HAD EUROPEAN CONSUMERS PROTESTED IN THE STREETS RATHER SIMPLY WRITING LETTERS, THERE WOULD HAVE BEEN A DIFFERENT OUTCOME.

-K.A.

(KATHERINE ALBRECHT, C-AUTHOR OF SPYCHIPS, AND FOUNDER OF CASPIAN)

From the very beginning of the vision there was a catch. As the internet as such is a fluke, a non-scripted phenomenon of absurd proportions (for on which other level is there such global cooperation?) it can not serve as a model for the yet to be made 'Internet of Things'. And what good does it do if my objects can talk to me and each other in Amsterdam only to go numb when I take them back home to Ghent? Still the vision has caught fire, wild fire. Currently there is no alternative, no competition for the dream of pervasive computing, ubicomp, Ambient intelligence, calm technology, the disappearing computer. Code, back-end, office, experience; whatever level you look at you find distributed computing with money making models at the customer end and a trend towards extreme convergence on the level of infrastructure and item (object) level.

Philips has sold their chip making divisions so as to not get caught up in the primary debate that this ambient move has sparked – privacy.¹³ Their bet is entirely on ambient narratives, the gameplay in homes and office spaces with wireless connectivities adding a layer of drama on top of everyday activities. One does not want the word RFID or NFC near as one does not want people to think about what is running in the background. One will take care of that.

That is catch number two. As Ambient intelligence interfaces with you through 'the environment', it requires that this environment remains stable. If it does not people realize very quickly that they are dependent on a wireless world they cannot access, tweak, hack, twist. The world becomes magical only when you lose your agency.

Just think back a decade or so. Did you not see cars on pavements and guys (mostly) trying to fix them? Where are they now? They are in professional garages as they all run on software. The guys cannot fix that. Now extrapolate this to your home, the streets you walk and drive on, the cities you roam, the offices in which you work. Can you imagine they would one day simply not function? Not open, close, give heat, air...

There is a political dimension to this longing, or rather inevitable thrust towards stability. As citizens will at some point soon no longer be aware of what we have lost in terms of personal agency. We will get very afraid of any kind of action, and probably also the very notion of change, innovation - resisting anything that will look like a drawback,

like losing something, losing functionalities, connectivities, the very stuff that they think is what makes us human. As such Ambient intelligence in its ultimate form of outsourcing human memories - from the pencil onwards - dispersing yourself as data into the environment has a deep appeal to us that goes beyond rational motives or socio-cultural reasons. We want to be safe, period. Not so much feel safe as that may change quickly. No, we want to be safe. Safety as the default position and then feel free. Wow. Could that be?

AmI carries this promise. But can it actually deliver? Just in practical terms, who will pay for the stability of these environments when oil prices go to \$300 or more? When climate change causes flooding in large areas? When millions of hungry people start to climb the walls of Fortress Europe? It is not hard to see that it is not arbitrary that the first applications of AmI are in the areas of access control, surveillance, the military and binary (biometric) identification schemes. There is a totalitarian streak in the heart of AmI. That is catch number three. Citizens will keep thinking they are not doing anything wrong, so bring in the cameras, bring in the drones, bring in the mosquitoes and chase away just the people under 18, not me as I'm 43. There is however no such thing as memory loss in an ambient world.

Dutch Procureur General Harm Brouwer likes RFID as it enables him to do proactive surveillance. If John goes to shop A and buys object B, then visits shop C and buys object D, we'll wait for him, arrest him at shop C. As we know the ingredients for making that bomb too. So the question for you, my friend, is what do you think will be wrong in five years from now looking at the course of Fortress Europe?

Catch number four is a beauty. There is no more public. The audience is really fragmented, scattered in narrowcasting across the blogs, RSS feeds and newsletters on the internet. The only way to get broadcasting attention is to create a hype, a scare, a threat. RFID in passports leaking your data, patents by industry to scan your garbage, a secret plot to chip all old people preventing them from going wandering off on their own. So in the moment 'the' public can be reached, it is not reached in terms of informed debate but from scandal to scandal. Creating a new one around the possible detrimental effects of AmI, won't last a week. Hacking RFID is necessary, but tedious and as long as you hack the tag, not the database, it is quite useless as a system hack.

Catch number five is a simple choice between the sea monsters from the Greek myths Scylla and Charybdis. Either the disciplining process that is going on at the level of national states will scale itself to even larger and damaging techno-logistic blocs and we must then fight that, period. Or the first cracks will show in the highly developed and techno-saturated countries and we will see civil war, or rather gang war and city states.

This will, I believe, begin in Europe within the next five to ten years. It is the same inevitable logic, the other side of the coin. You cannot give citizens gadgets with some functionalities and expect them not to use it and stay within the confines of national states that have outsourced their currency and law (85% out of Brussels and rising), privatised all their services and then still try to collect up to 40% of the income of citizens as tax. Rich Bolivians organise their own networks pretty quickly when they feel threatened at last. Middle class Europe will do the same.¹⁴ The middle class is about to pull the plug.

In December 2004, I was attending an EU CIRCLE Conference.¹⁵ I had prepared a short talk on e-culture, where the successful Dutch labs come from and why my media students were unable to see the space they only had to grab in order to set up similar

places. In the Dutch policy document 'van Internet naar E-cultuur' the transition towards a culture that is characterised and determined by digital processes was described as e-culture. The realisation at a policy level was e-culture is not just 'something to do with computers', but a new, digital dimension - more than just a new medium facilitating new forms of expression, and changing the roles played by cultural institutions, placing the audience and user increasingly centre stage.

These new forms of expression, changing roles of institutions, these new mobile media were making their mark on every aspect of our culture, mostly on our educational systems, ways of disseminating data, and ways of teaching. I described the shift in the Netherlands towards hybrid it/multimedia departments. These new courses – Communication & Multimedia Design – were very successful in the numbers of students that they draw.

From 2001 until 2004, I had been teaching theory at one such particular Communication & Multimedia Design School in Breda, one day a week, mainly to get an idea of the kind of students that would form our IT/media backbone for the next decade. The first observation is the difference in the nature of the visible manifestations of politics. There is no new Waag Society or V2 in sight, nor emerging. Waag Society and V2 are the Netherlands's most successful media labs. In less than fifteen years they have grown into academic nodes on SURFNET, the Dutch academic network. This is unprecedented. Never before has a group of autonomous, critical individuals been able to get their ideas, narrative, theories and projects accepted as credible in terms of the existing academic discourse in such a short time span. How was this possible? Because of the liberal climate in the eighties and early nineties in the Netherlands that allowed for bottom-up creative initiatives.

This was no longer a concern for my students in 2004. No Logo, culture jamming, public domain, open source networks stem from political strategies of a 80s and 90s generation for which the idea of politics is very much influenced by Gramscian notions on hegemony: in between forced consent and active dissent we find passive consent, cultural change precedes political change, and that changes must connect to an audience that is ready to respond. As Gramsci notes, "the supremacy of a social group manifests itself in two ways, as 'domination' and as 'intellectual and moral leadership'¹⁶ a social group dominates antagonistic groups, which it tends to 'liquidate', or to subjugate perhaps even by armed force; it leads kindred and allied groups. A social group can, and indeed must, already exercise 'leadership' before winning governmental power (this indeed is one of the principal conditions for the winning of such power); it subsequently becomes dominant when it exercises power, but even if it holds it firmly in its grasp, it must continue to 'lead' as well.

This idea of politics of scheming tactically (in time) to reach a particular location by an overall strategy (place) informed politics before and during the first decade of the internet. For the 'digikids', young people who have grown up with digital technology and connectivity, the network is not something to either reach for or fight off. It simply is. Because of this network default of a flat web structural surface of things, the very idea of strategy as it is intrinsically tied to the idea of place, makes no sense for why should you scheme towards reaching a particular place, when that place might not be there tomorrow? Or might be somewhere else? 'Just' a node in the network.

To my surprise and chagrin, this discourse was mirrored in the presentations of different ways youth acted in specific countries and circumstances (school, free time,

relations, etc.). I went back to the hotel and wrote *The New Middle Ages in the 21st Century A Plausible Scenario: Disintegration of Western-Europe's Nation States before a European Identity is Established* in one sitting.¹⁷ It played on the convergence of technical protocols – TCP/IP – that were never intended to enable international free worldwide delivery – the internet, and a supranational nation building scheme, Europe, that demanded that individual nations privatize and outsource tasks that were once seen as core tasks of a nation state (currency, law, telecom, military, and health).

TCP/IP is the set of network communication protocols – the language – of the Internet (Transmission Control Protocol/Internet Protocol) that ran officially on the ARPA network (the precursor of the internet) in 1983. Because of the military and academic background of the internet, the world wide web was made possible in 1993 with the browser 'Mosaic'. Had it been a commercial operation, we would be living in a world where we paid for a subscription to the Sony web to deliver an email to a friend in Japan from Philips Netherlands web.

It has allowed citizens to become professional managers of their lives through the internet, 3G and GPS and the ever growing possibilities of social networking applications and sites. The solidarities that still exist within the legislative frameworks and mental maps of citizens are rapidly being broken down by the inability of national states to deal with the current financial crisis, the rising oil and gas prices, climate change and the changing power shift towards the East. These national states have outsourced and privatised everything from their currency to their ability to make law and are de facto empty shells that function only as tax receiving institutes. Taking the Netherlands as an example, we see that as one the highest developed and technology saturated nations it has the highest rate of emigration in the EU, even higher than Poland.¹⁸

The Dutch white middle class is leaving the country because it no longer sees the Netherlands as its mental mirror of possibilities and because of the high pressure of regulations, laws and end-user disciplining (smoking in designated areas, compulsory behavior regulation in cars, homes and workspaces).

It is not hard to predict that this situation cannot last. To reiterate: you cannot equip citizens with tools and expect these not to be actually used. But if we look around the situation actually seems quite stable, even quite calm. This is because the logic of Ambient intelligence sets forth not only its own disappearance as success, but in doing so builds its own foundation as being 'natural', and inevitable. If as a citizen you can no longer fix your own car – which is a quite recent phenomenon – because it is software driven, you have lost more than your ability to fix your own car, you have lost the very belief in a situation in which there are no professional garages, no just in time logistics, no independent mechanics, no small initiatives.

If the environment becomes the interface, where are the buttons, where are the knobs? Ambient intelligence requires, as it interfaces with citizens on very superficial levels of agency – as it wants the intelligence 'running in the background' – a very stable society, quite calm and sterile. Any change in the background, in the axioms that make up the environment has tremendous consequences on the level of agency of citizens. They become helpless very soon, as they have no clue how to operate what is 'running in the background', let alone fix things if they go wrong. As such, Ambient intelligence presumes a totalizing, anti-democratic logic.

European poets and politicians have always been aware of the modularities of implementing ideas. Alphonse de Lamartine's keyword, of which he never tires, is peace:

“The people and the revolution are one and the same. When they entered upon the revolution, the people brought with them their new wants of labour, industry, instruction, agriculture, commerce, morality, welfare, property, cheap living, navigation, and civilisation. All these are the wants of peace. The people and peace are but one word”.¹⁹

Now, in 2008 too the people bring with them their new wants of labour, industry, instruction, agriculture, commerce, morality, welfare, property, cheap living, navigation, and civilisation. Little has changed in human needs in 300 years in living alone and living together in families, communities, regions, nations and United Nations. But the keyword has. It is not *peace* that seems to drive us. We too have “Fifty years of the freedom of thought, speech, and writing”, after WWII engulfed Europe. But what has it produced? Have “books, journals, and the internet accomplished that apostolic mission of European intelligence, reason”? No. They have produced *fear*.²⁰



FIGURE 2 | THE WATCH OUT TEAM IN ACTION IN OISTERWIJCK IN 2004.

One March afternoon in 2004 students from St. Joost Arts Academy, Breda set off for Oisterwijk, a lovely quiet provincial town. They were dressed in white suits, suits that made them look like weird medics, the kind of people who come to clean out your chicken farm after some horrible disease. Not the kind of people you would trust, at least that is what we thought. Some had sticks to point at dangerous things (such as the sky). Don't you trust it with all that satellite debris. Better watch out. Some had stickers that made icons of dangerous things. In a red triangle the dangerous object was represented in words: watch out an umbrella, watch out a window, watch out a tree. You can bump into these things, you know. You better watch out. Be careful. Hey!

The idea of this performance-like intervention was to elicit a reaction from the general public. Beforehand, we had expected a large section of them to get the joke. What happened instead was much more interesting, but also more disturbing. Whenever the team were asked where they had come from, they replied: "the government. We are the Watch Out Team, a new government-sponsored initiative". At the market they dished out "Watch Out" umbrella sticker to eager umbrella owners. I overheard one young girl telling her mother: "they should have done this much sooner".

We never realized how deep a ravine between this huge longing, this ocean of belief and the lack of credibility. As De Certeau argues, there is so much belief and so little credibility. We saw it played out in front of us. We did not look like clinical scary government spooks; no we were potential saviours, safeguarding the people, the public from harm in every which way.

The current dangers of this cultural/political axiom to highlight safety/insecurity as if there could ever be a safe default position, only leads to more fear, more distrust, more anger as incidents will inevitably happen and you will take the blame for not having been able to prevent them. The fear policy goes directly against the call for more and more innovation, whilst innovation needs a risk friendly environment. If you scare your population, very few risks will be taken.

Who are going to distribute themselves into such an environment? An environment that you are being reminded constantly of that is unsafe, and insecure? The mobile industries 3G and 4G PowerPoint presentations highlight a person surrounded by power stations that connect nodes that should give this person more agency. The security industries presentations highlight exactly the same but in their case the agency lies in the nodes, not in the person. For both the systems logic is the same: to distribute yourself, your data - into the environment. The key themes, the cultural and political views that shape the environment are insecurity, un-safety, and fear.

This is the axiomatic EU deadlock and its inevitable demise in the 21st century. The way that it posits and thinks of technology as techné – pervasive computing – requires unequivocally that its citizens *trust* the environment. The way that it posits and thinks of building communities – safety as the default – requires unequivocally that its citizens *distrust* the environment. In this dilemma there is no way out.

All its axiomatic requirements are met: the network has empowered and is empowering individual citizens to such an extent that they can start managing their private and public (is there a difference still?) lives for themselves, while Europe as an idea, as a story *is still to abstract for citizens to outsource their newly-gained perceived autonomy* to.

One does not have to study the data that planners think is data, such as the amount of EU citizens who actually voting for their national EU candidates or the EU constitution; or the lack of trust in their own population in even not organising a referendum. The

coming decade will see the crumbling of the European nation states, as the technoliterate middle class will script its own forms of solidarity (with its familiar national and international 'linked in networks') breaking with the 19th century installed democratic institutions starting with the health, educational and security systems, causing the start of new class wars between the disempowered vast majority of non-cognitariat unemployed and the cognitariat which breaks away from national solidarity.

Europe is a dying dynamic. Its citizens have no sense of solidarity neither across nor in their own nation states that can be politically addressed and intellectually exploited for public domains. Strategies and tactics of squatters and small oppositional groups are broadly adopted by the backbone of the democratic system: the middle class. Not in favour of establishing a strong public domain, or access for all, no for purely individual gain. It performs poorly in the global competitive key areas technology and R&D. The decisive difference in techné between the young, vibrant, alive nations such as China and India and the old, shivering, dying nations of Europe is easily shown in two stories.

Twenty years ago it took 100 pages to have an adequate repair manual for certain cars, now they hold over one million pages.²¹ Nevada, USA, past a resolution in 2007 stating that car companies should make diagnostic tools and information available for independent garages. "As cars get more sophisticated, the car companies have a huge amount of control over who has access to the systems", says Aaron Lowe of the Automotive Aftermarket Industry Association.²² The reason is simple: what drives a car nowadays is software-based. Six years ago the new 754i BMW sedan with the iDrive, also known as the miracle knob was designed, "through a computerised console, to replace more than 200 functions that control everything from the position of seats to aspects of the navigation of the car itself to climate, communications and entertainment systems". In May 2002 15,000 7-series were recalled. "BMW tried to do too many things at once with this car, and they underestimated the software problem", says Conley, ex-CEO of EPRO Corp. "Only two-thirds of hardware has been unleashed by software. There are so many predecessors and dependencies within software that it's like spaghetti-ware. It's not that easy to get all these little components to plug and play".²³

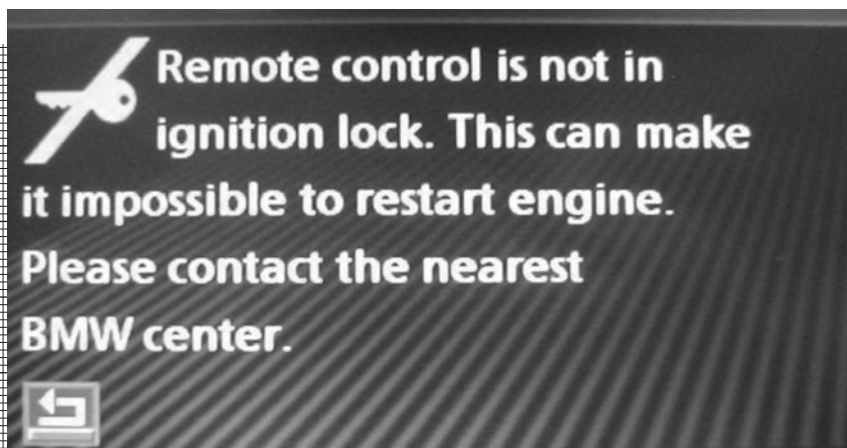

FIGURE 3 | SAY WHAT? SPAGHETTI-WARE FAILURE NOTICE ON THE 754I BMW SEDAN.

That is what you get when you hide all axiomatic code, protocol and procedural knowledge. If your car won't start you have to go to the nearest BMW Centre. If your neighbour's car will not start it is not advised to help him or her anymore as the electric current for your power cables could damage the engine. Imagine! Helping your neighbour is bad for your car. Now take a look at this car in Delhi.



We see the car, the engine and the tools to fix the engine, put it in the car and... drive it. We see code, protocol and procedure. Anyone with a mind to it can get to work on it. It is designed to be visible.

Europe's Future and Emergent Technology Programs as well as the major corporate labs have fallen unequivocally for Ambient which for the first time in the history of technology sets forth its own disappearance as technology as fundamental to its success.²⁴ The result will be dumb interfaces that hide all keys to the technology that drives it. Consequently it will keep citizens from being able not only to fix it when it is broken but to build on it, to play with it, to remake, remodel, and reuse it for their own ends. I believe this being able to negotiate stuff, stuff that is axiomatic thinking embodied, is called *creativity*.

From my interaction with the different groups I think it takes a certain critical mass of what might be called social techno-hackers, and in many places you have the socially engaged without a lot of experience beyond email (if that) and you have the open source coders whose world is pretty much online. My guess is the Bricolabs people are a combination of both, or am I wrong?

– Steve Cisler

3. Bricolabs

This is what Bricolabs should do – provide an alternative that encourages diversity and an educated and responsible citizenry by providing knowledge and artifacts to help local groups – wherever they are located – to develop innovative and culturally specific solutions.

– Matt Ratto

“In effect, we have allowed a situation to develop that is like a civilization devouring its seed corn. If an enemy had set out to do this to us -- quietly arranging so that almost no school child in America can tinker with line coding on his or her own -- any reasonably patriotic person would have called it an act of war”.

– David Brin

The term “Bricolab” was coined by the team at Coletivo Estilngue as part of the metaReciclagem or “metarecycling” idea being implemented in Brazil.²⁵ Bricolabs is a collaborative narrative²⁶ that can only be written in many voices, mine being only one. Three main threads of origin can be discerned: a strong Brazilian conceptual focus by Felipe Fonseca,²⁷ Stalker and descentro.org, the realism ingrained in the Gnu/Linux hacking attitude of dyne.org, Jaromil and the expertise of Aymeric Mansoux, and the strong conceptual ethnographic focus on ways of organizing and linking to policy and research by Bronac Ferran, Matt Ratto and Patrick Humphreys.

There are over ninety people on the Bricolabs list²⁸ and the names just mentioned are indicative of a way of thinking and practice. Says Felipe:

“Maybe Bricolabs are not meant to become an identity, but rather an open place for things to happen. Maybe Bricolabs already exist, and this name is only a way to map them”. “I think the real roots for that are before... in 1928 Oswald de Andrade published the Manifesto Antropófago - “cannibal manifesto”, posing comparing the development of Brazilian culture to the Brasindians habit of eating their enemies’ flesh once the battles were finished, in order to conquer the enemies’ strengths. From that to the Tropicália movement in the 60s and nowadays, when the few Brazilians who have internet access are among the three nations who spend more time online every week, when Brazil is among the first countries in amount of cracker attacks and - sure, when ideas such as MetaReciclagem gain ground and are developed all over the country. There is something there, but I haven’t been able to sit down and study more about it...”²⁹

In 2006 in San José during ISEA, I had been invited to co-chair the Pacific Rim Summit and had brought to that my experience with Gustaff Harriman Iskander who founded Common Room in Bandung and realized that because of its precarious model of sustenance, it was in fact more stable than western-styled new media labs like Media Lab Dublin (down after millions of Irish pounds could not hide the fact that it had no local grounding and the MIT model did not work out of the Boston context), Starlab Brussels

(tried to be ubiquitous before the rise of cheap hardware), IVREA (did not woo her financier Telecom Italia as it should have).

Apart from models for working, I felt that - as the Sarai Reader list so poignantly shows - people were beginning to map, debate, discover ways of writing and ways of publicising their everyday lives in cities. As much as counter-research, it was the emergence itself of a new kind of research that will have more repercussions for the academic research tradition than for the media places.

Eventually it will become the default. As with new media itself, the use of blogs, email, email lists, websites and mobile phones plays out fundamental changes on the news information mediascapes all over the world. Up-streaming says that the first pictures about incidents are now blogged before they are published. But most importantly there was a situation analogue to the one in the early nineties where people all over the world discovered the internet, either before or after the www (1993) and were facing the same code, the same hardware, the same interfaces and access tools (keyboard and mouse) in Amsterdam, New York, Moscow, Cape Town and Riga. Rasa Smite from RIXC in Riga claimed that the main reason for them to start a new media lab was the fact that it was new for everyone. No locality had an overview, a deeper history or better insights. The saturation of networking through fibre in some places caused as much drawbacks (a focus on interaction and interface) as it had positive effects (mass adoption).

Now, a decade later - in the beginning of the 21st century we are witnessing the same process. RFID is pervasive and global. The computing paradigm of ambient, pervasive computing, ubiquitous computing, calm technology is adopted by all players in the computing industry, from logistics, wireless infrastructures, domotics, smart textiles, grid computing to design practice which has adopted the notion of seamless as a fundamental feat of successful design.

The rapid growth of wealth in Asia means massive leapfrogging. If Japan wants to experiment it wires up an entire area in Kobe. South Korea is building New Song Do City³⁰ the first city with more “soft” architecture – what you see and where you can go is determined by your access - than hard architecture.³¹ China is installing the latest surveillance and security systems. As they do not build on prior notions of negotiating space and identity – which ideally formed the basis of the older layers of technology of control – these sophisticated systems will be regarded as the new basic infrastructure.³² In Karachi, population-wise the second largest city in the world, with over half of the twenty million people in slums, face recognition and number plate recognition camera’s reign sovereign on the highways.

Green Lanes³³ is a project that has Heineken’s crates of beer through customs worldwide like clockwork. Green Lanes entails large scale cooperation of all players in the supply chain to bring down the difficulties of having about thirty documents for one single container crossing a border: “A unified data system would allow changes in information about product sizes, weight, name, price, classification, transport requirements and volumes to be immediately transmitted along the supply chain. For example it would allow shippers to immediately know *if the amount of product stacked on a pallet had changed*, or give a retailer time to adjust display space”. You used to be able to spot one person taking one crate of Heineken from a pallet next to you, and you’d say: “Hey, better leave that crate alone!” Well, now you sit in a control room in Rotterdam and if one crate disappears in Hong Kong, you know and alert your colleagues overseas.

As such, we can begin to develop an analysis of the current situation which looks like this: Local situations face and develop in relation to a global trend in computing; they bounce as it were off the ceiling of that is globally tied together through the convergence of back-end systems (RFID, logistics, surveillance, green lanes) and mobile telephones (and its expensive priced business models).³⁴ Every situation bounces off differently. One of the key *brico questions* is if it would be possible to find some 'formula' to determine how particular situations would bounce off, and if it were at all possible to find a kind of algorithm that would predict how particular situations would respond and develop. If so, could it be the key parallel or counter - movement for the current all pervasive speculation capitalism entering its final phase of perversity in the banking crisis and food riots we are seeing today?

The idea of Bricolabs could only take off in a Brazilian context. First, for the concept of open source hardware to be articulated not only in an artistic context of one off works, but as a possibility to create generic and open infrastructures, it was necessary that a philosophy of open content and open source software was already well developed in actual praxis of MetaReciclagem (2002) and pontos de cultura. MetaReciclagem can be seen as a process to raise the sensibility of people about the inner workings of technologies. MetaReciclagem is mostly an idea.³⁵ An idea about the appropriation of technology for social transformation.

Second, because any conceptual framework as such was not strong enough to build a critical identity, it either had to 'click' personally with people or there were already strong ties, as Felipe explained: "Some people in this list are my good friends. That might be more important to me than the others, but I think it is a key factor. I'm not here only because I share a conceptual interest with other people".

The third key factor at this initial stage was conceptual architect and then Director of Interdisciplinary Arts at the Arts Council of England (until end of March 2007) Bronac Ferran.³⁶ With her skills of negotiating new ways of working and her ability to see beyond strategy and tactics, she brought in Matt Ratto (then Virtual Knowledge Institute, Amsterdam).³⁷ Paulo Hartmann took us with his friend August to Prestes Maia to see this 1600 people squat. Extremely well organised, every floor has to be negotiated by Vanya who is making dresses, T-shirts, clothes and dolls on the fourth floor. Here the idea sprang up to do a wearables workshop with her garments, a plan still in the pipeline. Bronac and I were impressed by the level of organization and the library on the ground floor, all books neatly lined up. We were also shown the computer room which was quite messed up and thought about trying to bring in equipment. Later Felipe told us that that is exactly what they had been doing but because of different factions in the building the equipment did not stay there long.



FIGURE 5 | ROB, VENZHA AND JAROMIL IN PARIS.

In January 2007, Enter Festival director Annette Wolfsberger suggested to Matthieu Margaruin of Mal au Pixel in Paris that both festivals host a Bricolabs workshop, thus also being able to share the costs of bringing Venzha Christiawan from Yogyakarta to Europe.³⁸ A month³⁹ before that Jaromil⁴⁰ had given his consent to be part of Bricolabs, in the sense that for him it was a special network that was able to articulate broad views that he himself did not necessarily agree with. The second edition of Mal au Pixel festival, was held in April 2007, just before the first round of the French presidential election. It was organised by Ars Longa, Confluences, Mains d'Ouvres and the Institut Finlandais. Within this pre-election context, Mal au Pixel addressed the question of how artists, researchers and grassroots communities working in the field of media can contribute to understanding, critiquing, developing and inventing our political and social systems. Jean-Noël Montagné (Craslab) introduced his focus on open source movement and Bricolabs initiative as driven by the necessity to give other possibilities to citizens in their day life to face the actual global economic model.

The conveners of this workshop, he said, along with many others, are currently developing novel means for exchanging knowledge between “Bricolabs”, distributed sites that explore the potentialities of pervasive information technologies in an open context. The central theme is that of “re-working”, “re-using”, and “re-purposing” existing infrastructures in order to develop novel forms of knowledge exchange between artists, technologists, and socio-technical theorists, as well as the development of new models for innovation in business and in society more generally. In his view:

“We must start new democratic processes plainly integrating local and global contexts in economy, environment, education, science, culture etc, and plainly restoring the citizen as a major actor in the global community. We all know open source software, documents and recently hardware, and we just discover now that the open source concepts, techniques and ethics concern all schemes of human presence in this small and fragile planet. The Bricolabs laboratory is one opportunity to contribute to such discoveries and applications”.

The workshop⁴¹ consisted of short presentations on the recent new possibilities of open source software, content and hardware and its promises for real democratic generic infrastructures (non branded, non IP) from your average electricity supply, your automobiles (OScar), your connectivities (mobile infrastructure). Bricolabs; a series of labs all over the world that work on shared objects, not so much through a shared philosophy. Apart from presentations there were two participatory strands: 1) a scenario workshop on what generic infrastructures would mean for you, your house, your street, your life, and 2) hands-on experience on employing GNU/Linux for digital artisanship and tactical media, hacking cheap game consoles.⁴²

JAROMIL ON PIRACY

“I got into Bricolabs building software to let people produce things for themselves easily and recycling available hardware, this is the point of contact with Felipe Fonseca and the MetaReciclagem initiatives in Brazil. We should be careful about what we do ourselves and wonder - at every step - if we need more hardware in a world already full of it. Instead of spending resources on creating new objects we should, perhaps, first look to exploit and explore to the fullest what is already available. Then we need to create alternative infrastructures to run everything on every object.

Within young networks - as dyne.org and goto10.org - we already have a very performative social mesh network of artists, activists and hackers. For several years hackers have been meeting in hack meetings and hack labs: temporary autonomous zones, fluid spaces that come and go, where it has always been possible to tackle issues directly, free from commercial interests and manipulations, free from censorship on disclosing systemic flaws. While companies are harvesting the know-how that actually comes from such an underground, these are the initiatives that keep it alive and nurture its wisdom.

We talk about attitude, since that is a better term than ethics to conjugate practices into ideas, it puts forward practical solutions, whereas ethics has a history of manifestos. This is not a time for manifestos, this is a time for "how to".

I can see the utopia of Bricolabs in a communication device offering an open platform for both developers and designers, following with the creation of an open market for exchange, without monopolies lead by industries, without any property following the objects but with a freedom that is inherited by any possessor.

To analyse how that can be (and should be) possible let me draw your attention to the game industry, which has been one the most developed branches of modern consumer electronics. In such a context, technology's notion of "trusted computing" has been already implemented (and indeed failed to work reliably) for several years, since this huge market existed. As a result to the impossibility to enforce control on the deployment of electronic devices by their legitimate owners, the games industry has ended up calling piracy an activity of re-deploying devices for purposes "they were not originally built for, nor licensed to the users". This generates a persecution for legitimate users and people trying to build local economies on the legitimate possession of generic devices.

As a matter of fact such "piracy" practices are widespread across the world, especially the southern hemisphere, as underground economies that support the weaker areas of society and their development. On a wider historical perspective it is worth to consider professor Doron Ben-Atar's *Trade Secrets: Intellectual Piracy and the Origins of American Industrial Power*.⁴³

"During the first decades of America's existence as a nation, private citizens, voluntary associations, and government officials encouraged the smuggling of European inventions and artisans to the New World. These actions openly violated the intellectual property regimes of European nations. At the same time, the young republic was developing policies that set new standards for protecting industrial innovations. The American patent law of 1790 restricted patents exclusively to original inventors and established the principle that prior use anywhere in the world was grounds to invalidate a patent. But the story behind the story is a little more complicated - and leaders of the developing world would be wise to look more closely at how the US system operated in its first 50 years. In theory the United States pioneered a new standard of intellectual property that set the highest possible requirements for patent protection-worldwide originality and novelty. In practice, the country encouraged widespread intellectual piracy and industrial espionage. Piracy took place with the full knowledge and sometimes even aggressive encouragement of government officials.

Congress never protected the intellectual property of European authors and inventors, and Americans did not pay for the reprinting of literary works and

unlicensed use of patented inventions. What fueled the 19th century American boom was a dual system of principled commitment to an intellectual property regime combined with absence of commitment to enforce these laws. This ambiguous order generated innovation by promising patent monopolies. At the same time, by declining to crack down on technology pirates, it allowed for rapid dissemination of innovation that made American products better and cheaper”.

Let's keep in mind here we are not focusing on piracy of content, but on claims of 'piracy of tools', while modifying a PlayStation to run homebrew software is legitimate for its possessors, for instance to recycle the device and employ its computing power for activities that can be way more productive and creative as running a game.

There are small villages where the only electronic devices available are game consoles (for popular demand) and even in the middle of an Indonesian jungle the villages have their gaming play-clubs. Such game consoles and technologically equipped media-centers can absolve many more important roles, as routing information for farmers for example.

Furthermore, several exemplars of such devices are available on the second-hand market as cheap toys made obsolete by more recent versions, it is possible to have an artisanal economy growing around the refurbishing of such technologies.

Such practices as “modding” or “chipping” game devices have been currently ruled as legal in Italy and the UK (and hopefully some other states of EU) on the basis of consumer rights, although there are urgent threats as the ACTA or the IPRED2.

Bricolabs can be a vehicle for opening up negotiations with governments and industries to find a common ground. We claim the right to run any software on the devices we own and to re-distribute them as we like. Devices should be built free to run anything. As software shapes our social interaction and communication topologies, the act of theft is where the people is deprived of their rights to re-use and re-create their own schemes of interaction with the devices they share.

Game consoles are hacked everywhere. A lot of dry, technical papers are online on how to “mod” [modify] the chip. In border nations and the peripheries of the cities, piracy is a stable (the most stable) source of income for a large mass of the poor and immigrants – it has been like this with cigarette monopolies before. How to develop then? How to match it with trusted computing? And how we are going to interact with the consumer approach: player free - producer buy?

In 2002 we cracked the Xbox console to run GNU/Linux. In certain places of the world dyne:bolic was the first GNU/Linux CD reviewed and distributed by game magazines: it was a cultural and technological hack. We made the \$100 dollar computing without polluting the world with more hardware. Bricolabs is about affordable used hardware that can run anything, available in large numbers, democratic and hackable.

The horizon of Bricolabs is shared with recent developments on GNU/Linux: provide easy to use toolchains to compile software for these devices and documentation on how to do it. Digital artisanal practices claim a market that should be left open by corporate powers holding their rights on all what we use”.

FALSE THINGS

In Carl Schmitt's political philosophy he makes a distinction between the real enemy ("Wirkliche Feind") and the absolute enemy ("Absolute Feind"). This latter enemy is, according to him "der eigene Frage als Gestalt". That which negates your own position, that which questions your very existence, embodied. Here is an example:



FIGURE 6 | ARRESTED DEVELOPMENT: THE CONTROVERSIAL SKYPE PHONE.

This is a Skype phone. It belongs to Alexei Blinov. Alexei is one of the lead developers of Hive Networks. He is very angry with this object and the likes of it. What we have here, he says, is an object, a piece of hardware that in itself holds quite some computational power and potentialities, yet has been deliberately crippled and handicapped to perform only one trick, search for wireless, connect and Skype. Are we going back to the days where phones were directly connected together in pairs and users had separate "telephones wired to the various places he might wish to reach?"

Apart from issues of durability, sustainability and climate change that the manufacturing and dissolving of these anomalies of devices raise, far more important is the nefarious relationship it entails and scripts between people and things. The Skype phone very literally is '*der eigene Frage als Gestalt*', as such it is a false thing, an object that deliberately obscures its potentialities instead of highlighting them or show enabling qualities. It is this thinking through waste that fuels the anger of open hardware developers and has inspired descentro.org and MetaReciclagem to rethink the connectivity chain in terms of functionalities, not devices.⁴⁴ Otherwise we will be flooded by devices that embody a functionality (voice communication) that is a voice over IP (Voip) application in a device (personal computer/laptop) that uses telephone cables or wireless connectivity to communicate in the first place.

On hivenetworks.net the developers define Hive Network as a “ubiquitous infrastructure that can see, hear, touch and talk to people.



It is a concept centered on content generation, dissemination and freedom, and not just connectivity”:

“Hive devices convert everyday networking devices, such as a network router, into multi-functional ones with expanded possibilities. The conversion is done by replacing the pre-installed software of these networking devices with the open source Hivewares, which then allows new hardware to be plugged in. Examples include hard disks, web cameras, speakers, FM transmitters, weather stations and many other hardware tools.

At it’s simplest with no external devices attached a Hive device is a small, low-power, computer running a simplified version of Linux. Usually the base unit has been built from a network appliance, so network routing and other related technologies/services will already be available.

Limited only by imagination, Hive devices become more useful when external accessories are added. These accessories are often connected by USB and include web cameras, speakers, FM transmitters, I/O boards, and Bluetooth dongles. These can be used to play or broadcast audio, take images, control electronic equipment, and send files to Bluetooth devices (mobile phones, hand held computers and laptops). We call the software that controls these functions on the Hive device Personalities, which are discussed in detail in other sections of this site. They are configured using a simple web interface, a process that the majority of users will be familiar with. This interface also allows the user to control individual Hive devices or groups of devices”.⁴⁵

In *Separating and Containing People and Things in Mongolia*, Rebecca Empson writes: “... the doing involved in making things visible or invisible makes relations. In this sense ‘vision’ becomes the tool by which relations are created”.⁴⁶ Things are made into Hive devices by the act of making them into Hive devices. The doing makes the transformation real, the performative act is critical. In this sense ‘coding’ becomes the tool by which relations are created. By removing the manufacturer’s software on the Asus WL-HDD and replacing it with the Hive firmware – “experimental Open Source software” – it becomes a different thing in more than a constructivist sense, a new object is created:

“It is for this reason, for example, that the claim that when Cuban diviners say that powder is power they are speaking of a different powder (and a different power also) is not a ‘constructivist’ claim. To put it in Foucauldian terms, the point is not that the discursive claims (eg. ‘powder is power’) order reality in different ways – according to different ‘regimes of truth’ – but rather that they create new objects (e.g. powerful powder) in the very act of enunciating new concepts (eg. powerful powder)”.

In *Art and Agency, an Anthropological Theory*⁴⁷, Alfred Gell puts emphasis “upon art as a form of instrumental action: the making of things as a means of influencing the thoughts and actions of others”. He defines *volt sorcery* as the “practice of inflicting harm on the prototype of an index by inflicting harm on the index, for example, sticking pins into a wax image of the prototype”. In Gell’s theory the index is located in the region where the sphere of agency (the primary agent) overlaps with the vulnerability of the *causal milieu* of the recipient. In our case the index is located in the region where the sphere of agency of the firmware on the hard disks (control) overlaps with its openness to different practices and interpretations by the hive software. The question is, can we immobilize or reformulate the subject (the set of business practices and real people articulating their agency through these business practices of patents and intellectual property laws) in this way? Seizing and scheming towards this opportunity to make sense, to have fully analyzed and grasped a situation – such as the recent individual agency in open source content-networks-software and hardware – will not lead to major organizational, political, and design breakthroughs, if we are not able to fully grasp the trajectory from thing as gathering places for spaces and discussion, from ‘matters of concern’:

“A heuristic use of the term ‘thing’ has also been adopted by Bruno Latour, who, after Heidegger, has worked to transform the semantic emphasis of ‘things’ from ‘matters of concern’. Drawing on older etymologies in which ‘thing’ denoted a gathering place, a space for discussion and negotiation; Latour has rehabilitated this sense of the term as a way out of the twin cul-de-sac of constructivism and objectivity”.

The story is no longer metaphor, no longer as if or ‘as’ something else, no, the story is the thing now, it is the protocol.

Thus Bricolabs could be the leader of a new movement that Aymeric Mansoux would call “fair-trade hardware”. In his opinion, industrial could label a device “fair-trade hardware” if:

- Its specifications are clearly documented in an open-content licensing fashion and do not rely on any proprietary components;
- Its design/production/manufacturing have been done in a country where human

- rights and labor rights are not violated;
- Its design/production/manufacturing has been done with a focus on maximizing recyclability and prevention of pollution;
- It is based on components that are traceable and on which the fair-trade hardware rules can be applied to.

He says: “We have a very performative social mesh network of artists, activists and hackers, it is all out there and the choice – and it is a choice – is yours. Do you want to live in the towers of controlled information and formats of participation or do you want to be free, as information wants to be free? Where do you want to live?”

THE REPRAP AND THE BRICOPHONE

If things are embodied spaces for negotiation, we must be careful if we want to be respectful. So yes I know that in a few months (oh, I hope somewhat longer) I have to get rid of my beautiful black Macbook. How I get a sensuous feeling from this trying to locate the wireless antenna on the black smooth surface. Just the idea of a clean blue desktop screen, folders neatly lined up on my right, activity monitors up and running, 100% of battery power, hmmm. Yet, it is such a beautifully packaged set of proprietary protocols.

During a brainstorm at LSE earlier this year, Stewart Brand’s Shearer Layers brought on the idea of community use of cheap 3D printers. Chris Hand pointed to the Dishmaker,⁴⁹ which led Jim Kosem to propose a project for local manufacturing. His main argument is that as transportation is now still cheap, this will not remain so as eventually all its costs in terms of climate change will be realistically charged. The question is when will it stop? What happens if we take real production and manufacturing capacities to the level of community centers, schools, hospitals, and nursing homes?

In his 1930 text *The Revolt of the Masses* Jose Ortega y Gasset elaborates on the “one the fact which, whether for good or ill, is of utmost importance in the public life of Europe at the present moment. This fact is the accession of the masses to complete social power”.⁵⁰ This social power is for him determined by actual presence, corporeal visibility:

“Perhaps the best line of approach to this historical phenomenon may be found by turning our attention to a visual experience, stressing one aspect of our epoch which is plain to our very eyes. This fact is quite simple to enunciate, though not so to analyze. I shall call it the fact of agglomeration, of “plenitude”. Towns are full of people, houses full of tenants, hotels full of guests, trains full of travelers, cafes full of customers, parks full of promenaders, consulting-rooms of famous doctor’s fun of patients, theatres full of spectators, and beaches full of bathers. What previously was, in general, no problem, now begins to be an everyday one, namely, to find room. That is all. Can there be any fact simpler, more patent more constant in actual life?”

For Ortega y Gasset, social power is asserted through physical presence, citizens asserting themselves as individuals, not behaving according to certain socio-cultural rules of genre forcing them into not being there, or at least not seeming to be. As they become visible in the streets, their very presence can be offensive. What will happen if

citizens apart from simply *be* now also start to *act* instead of consume? Mapping their own street infrastructures, energy supplies, pollution levels? Making their wireless networks, open source defibrillators, and washing machines?²³¹ And why not, making their protocols for living together, too? What would stop them?

This movement of digital technology towards our everyday life and our daily encounters in the streets, which are themselves becoming a digital territory, a hybrid space made up of services and communication protocols, is – as we have seen - currently being negotiated by the logistics, retail, telecommunications and security industries.

We are at a crossroads where artists and designers are not only increasingly taking control over the very principles and materiality of the ‘network waves’, but also are more determined to make local applications for everyday use.

REPRAP [BY SEAN DODSON]

The idea of a machine that could produce a copy of itself has eluded some of the greatest minds in history. René Descartes heads a list of philosophers, mathematicians and physicists who have long pondered the potential of a self-replicating machine. As have writers of science fiction, who have been also quick to warn of the dangers of unleashing such a powerful technology upon the world. But for both sets of thinkers the reality of a self-replicating machine has lain somewhere just beyond our reach.

Dr. Adrian Bowyer of the University of Bath is a quietly spoken, twinkle-eyed 55-year old senior lecturer at the school of mechanical engineering and inventor of the RepRap machine. Earlier this year at Cheltenham’s Science Festival Bowyer in England, Bowyer, along with the New Zealand scientist Vik Oliver, unveiled a RepRap machine that had had the majority of its working parts “printed out” from an earlier prototype. Although the RepRap was first assembled in 2006, this was the first time a parent and child machine had appeared side-by-side.

Technically, the RepRap machine is a form of rapid prototyper, the kind used by designers and engineers to streamline everything from aircraft to hairdryers, but it’s easier to think of it as a printer of three-dimensional objects. The RepRap works - essentially - like the desktop printer you might have at home, but instead of printing on paper, the RepRap makes hard copy in three-dimensions out of plastic from models designed on a computer.

Even before you get into the benefits of self-replication, the RepRap is already an impressive achievement. Bowyer and an army of international helpers – all operating under an “open source” have managed to scale-down the cost of rapid prototypers from tens of thousands of pounds to around £250. But it is the RepRaps ability to produce its own parts (which could then produce another machine and so on) that has won Bowyer acclaim from the likes of the inventor James Dyson and executives at Google.

Bowyer describes his RepRap as a “potentially an extremely powerful technology” that could “give everybody - ultimately - the ability to make virtually anything for themselves in return for being helped to reproduce”. For the moment it makes crude plastic knick-knacks (sandals, coat hooks, door handles and fly-swatters), but it has the potential to develop into something that could make much more sophisticated artefacts, including the ability to lay its own circuitry.

Like Bowyer himself, the RepRap itself is a humble thing to witness. It’s fairly small, little bigger in volume than a portable television, barely more than a frame assembled from long pieces of screw-grooved studding and a large number of plastic parts. At its

heart is an all important “extruder”, poised to squeeze out a small film of molten plastic from a nozzle which is fed from a coil of white filament, held in an empty drinks bottle suspended from the ceiling. It looks vaguely like a cut-price textile machine, no more a radical piece of technology than a knitter of jumpers or a sewer of buttons.

It takes about two hours to “print out” each small part. It takes hundreds of hours to make the parts for a “child” machine. After Bowyer sets the nozzle to work producing, say, a simple coat hook, each object is produced line-by-line, layer-upon-layer. Not that that should temper your enthusiasm. If you think back, the first ever digitized images took hours to process. Now, 20 years later, such things are commonplace, done in a flash on a mobile phone.

If you are still not convinced, perhaps it helps to take a longer view. The idea of a self-replicating machine can be traced back to remarks made by the Queen of Sweden to Rene Descartes, but they were more seriously explored in the 19th century by the novelist Samuel Butler who described a machine that could mimic the biological process of plants in his novel *Erewhon*. Then, the Hungarian mathematician John von Neumann took up the idea with the theory of a “universal constructor” in the middle of the last century, before the English-born physicist Freeman Dyson proposed a self-replicating system to be sent to Saturn’s moon Enceladus. His theories were later taken up by Nasa who drew up plans to employ them in the building of a lunar base.

Science fiction writers have kept pace. Phillip K Dick, Arthur C Clarke and noble-nominated Karel Čapek have all toyed with the idea, before John Sladek (who like Bowyer studied as a mechanical engineer), based his 1968 satirical novel, *The Reproductive System*, on a self-replicating machine - that lost control. It set the scene for movies like the Terminator, and later the Matrix, to tap into human fears of self-aware robots capable of reproducing and taking over.

Bowyer thinks his RepRap will prove much more benign. Besides his machine needs careful assembly (meaning it can’t self-assemble) and it cannot yet reproduce all its own parts. These last two points do make you wonder if the RepRap a self-replicating machine at all. After all, machines have made other machines since, well, the dawn of mechanics. A lathe could be used to make parts for another lathe, what’s so different about his RepRap? “You could see the whole of engineering as effectively a self-replicating machine”, Bowyer admits, “but we are different in degrees not in kind. It’s very difficult to use a machine tool to make another copy of itself but RepRap is designed to make that as easy as possible. The bits and pieces that it makes are both numerous and simple, so that almost anybody can do it”.

Even though the RepRap is a child’s play to operate, it remains difficult to build. To do so you have to have an ability to write your own computer code, be confident with a soldering iron and have some grasp of mechanics. These bits already amount to 60% (all the plastic parts) while the rest can be bought cheaply and easily from a simple hardware shop. It is believed that there are already around 100 RepRaps in the world, mostly made by small groups who share the skill-sets necessary to build one.

Bowyer thinks this model is perfectly suited to small groups to develop products who would otherwise struggle in normal economic circumstances. “It means that communities in the developing world manage to get one foot on the rung of the manufacturing ladder”, he says.

“Even in China you have to spend half a billion to create a fabrication line. You can pay people low wages but you have to make an enormous capital investment in order to

make things. The thing about RepRap is that it allows you to make stuff with a very small capital investment. If you are a community that has one, you can have several machines once you have got one and what's more you can give a machine to your neighbours down the road and they can do the same thing. A very powerful mechanism for elevating people for the most extreme poverty".

Soon, he says communities in places like Africa will be able to download instructions for a RepRap and use it to replicate further machines, almost endlessly. Because the plans are open source, such communities will have to pay no royalties for the patent. But he adds such a noble stance is inevitable anyway: "After about four minutes after I had realised that it had to be Open Source to be fair", he explains. "I realised that if you have a self-replicating machine, you've got to give it away anyway because there's nothing to sell. If I knock it out for £1000 you can replicate it and knock it out for £900. Sooner or later you are down to the cost of the raw materials". And there is, he says, no fortune in that and, anyway, he doesn't want to spend the rest of his life in court trying to prevent people from "doing with the machine the one thing it was designed to do. "You are ineluctably brought to the point where you have to say this is a self-replicating machine the only sensible thing to do is give it away for free".

The RepRap needs to get much, much faster before it can even begin to realise its potential, but its still early days for a device – even though it has been dreamt of since the dawn of the enlightenment – and Bowyer is not done yet. Soon, he plans to design a shredder for the machine, so old items created on the RepRap can be reduced back to granules of plastic to be reused again and again. Think about it, he says; "you could shred your milk bottles and make a pair of sandals, what's more when the child grows out of the shoes you shred them, add another milk bottle, rescale the design and you have got a new pair". If nothing else the RepRap could prove to be the ultimate recycling machine.

BRICOPHONE⁵²

The *Bricophone* is a community-oriented mobile phone infrastructure using Open Source principles. It is a low-cost, low-energy, open hardware, open source project built for communities of up to ten thousand people within regions. The characteristic of the Bricophone infrastructure is that it does not require any static infrastructure like relays, antennas, or digital data centers. This provides the opportunity for special uses in poor communities, mass rescuing in disaster areas, and cultural and social activities like festivals and other mass events. In January 2008 Jean Noël Montagné and Philippe Langlois launched the initiative from Craslab Paris.⁵³ It got a small grant from the Dutch open source funder, nl.net.⁵⁴

Jean Noël says: A new world is emerging where the processes of transfer of knowledge, goods and services are submitted to ethic laws: transparency, democracy, collective intelligence, collaborative organisation, sharing of any resource including environmental resource. These new economic, politic, cultural, social possibilities are strongly related to the digital world existence: digital industry, digital networks and digital freedom. This is their power, but also their important fragility. I see Bricolabs initiative as a tool to discover, document and promote all open source projects in the world, with strong emphasis on digital democracy. Bricolabs could serve to gather or inform similar initiatives actually working separately in different parts of the world.

Some examples in different fields:

- Open source hardware to desalinate sea water;
- Open source software to mesh individual wifi routers;
- Open source management process for Social Grocery;
- Open source organisation process for local democracy referendum;
- Open source educational resources for personal health management in hot countries.

NO MORE OPPOSITION?

According to Jens Kastner in his recent *Transnationale Guerilla* it is a deep anti-classification principle that underlies the current radical positions that aim to find governing principles for a non capitalist society:⁵⁴

“Everyone originates in an omnipresence of structural violence, but they grasp it differently according to their respective theoretical development: “repressive society” (Holloway), “deregulated violence” (Baumann) or “generalized state of emergency” (Agamben). All three think that the mechanisms of identifying and classifying are essential for this. For that reason they develop from their diagnostics of time normative approaches that – thirdly – have something common: to be against classification. [~ assorting?] On this anti-classification base they phrase – fourthly – all three their concept of community”.⁵⁵

Yet if these theoretical roadmaps to a fundamental change in politics - however different in scope they may be - are consistently build on a resistance to classify, de/reconstruct, it is very hard to see how they can succeed as opposition and as roadmap to a newly envisaged society as anti-classification has become inconceivable in itself, not only as practice or theoretical position, but as any point of departure that could bring forth a strategy for thought or action. It becomes clear that in order to be under surveillance one only has to ‘be’ as definitions of good and bad are context dependent. As Lieutenant Colonel Kathy De Bolt, Deputy Director of the US Army Battle Laboratory at Fort Huachuca, Arizona, explains the aims and goals BAT, the biometric system that is being developed in order to realise this global and omniscient capability of eyes and ears everywhere: the Biometrics Automated Toolset. “Any place we go into – Iraq or wherever – we’re going to start building a dossier on people of interest to intelligence... We’re trying to collect every biometric on every bad guy that we can”.⁵⁶

In order to find productive principles we will have to make two moves; one is to go back to the arguments that led to *l’Encyclopédie of Diderot et d’Alembert* and see if we can find through their arguments a way to unthink and undo the classification as default (every object on the planet can have its own ip address with IPv6)⁵⁷ and the other one is to find a way to articulate as performative practice the idea of a parallel movement without recursing to a mode of opposition based on anti classification , or oppositional ways of working. Jean Le Rond d’Alembert writes in Preliminary Discourse to the Encyclopedia of Diderot:

“... it is perhaps among the artisans that one should go to find the most admirable proofs of the sagacity, the patience, and the resources of the intellect. I admit that the greater part of the arts has been invented little by little and that it has taken a very long period of centuries in order to bring watches, for example, to the point of

perfection that we see. But is it not the same for the sciences? How many discoveries which immortalized their authors were prepared for by the work of the preceding centuries, even having been developed to their maturity, right up to the point that they demanded only one more step to be taken? And not to leave watch-making, why do we not esteem those to whom we owe the fusee, the escapement, and the repeating works [of watches] as much as we esteem those who have successively worked on perfecting algebra? Moreover, if I can believe those philosophers who do not so despise the mechanical arts that they refuse to study them, there are certain machines so complicated, and in which all the parts depend so much on each other, that it is difficult to imagine that the invention would be due to more than one man”.

Not only is the mechanical seen as a collaborative effort and process, but the mechanical arts are thought on the same conceptual level as the arts and the sciences, especially because the knowledge gained and the theories put forward build upon layers and layers of collaborative practical experience. The project of the *Encyclopédie* is the starting point for all questions relating to the Enlightenment and “the project of the modern library itself”. Yet does this mean that there is no other reading possible in the intentions of the authors of this paradigm of classification? *Le Rêve d’Alembert* (1769, first published 1820) shows that for Diderot seeing the world no longer as God but as machine, and seeing Nature as a giant evolutionary organism that is never static but always experimenting, is not contradictory at all. Maybe the process of and will to classify is not the key to begin to dismantle neoliberal capitalism. But if not, then what?

According to Jens Kastner: “However the transnational guerilla may be seen as a try to overcome the frequencies of fields between art and activism described by Bordieu. The respectively own logics of production of theory, art and also politic actions show overlapping and entanglement. This is the basis where it is meant to prepare - however not by identical closements or prefaced contextless communities. But as a transnational guerilla”.

- The intrinsic bridge between artistic and social movements offers possibilities to overcome the structural hurdles between these two.
- Universalism as imaginary (the re-connecting of universalism has a certain source in negation of the existing, which defines the artistic internationalism. This is followed by transnational guerilla, as criticism and as an alternative model to the universal community.
- Zapatista self-management and tactics (“Intergalactic meetings against neoliberalism and pro humanism/the human race”, where a few thousands guerill@s [~guerilleros?], intellectuals and activists [orig. germ.: AktistInnen, must mean AktivistInnen] in the chiapanestic jungle (1996) and also in Spain (1997) met, can be seen without hesitation as the birth hour of the globalization-critical movements. It can also be understood as the starting point of the Transnational Guerilla.
- Global mobilisation (in a normative regard transnational guerilla means to step across national borders and at the time it is also a moment of movement beyond traditional or geographic bonds. This is exactly what the TG is trying to achieve: to

create a transnational mode of movement out of the artistic internationalism of the 1960's.

- Multiplicity (For this collective and de-discriminating action a decisive hint is necessary, [which can also be described as] the temporary mark, the come across, the masks of the Zapatistas, the exposing of one's mode of existence.
- Parallel action (to speak about TG arises the assumption to be part of a minority: not to assign oneself to a suppressed group for reasons of misinterpreted political correctness, but to conclude oneself, to understand oneself as part of a just temporarily secret broad community.
- Pragmatic activism (TG is not a so far un-perfect or an up to now uncomplete community, neither an historical horizon to be fulfilled. It leaves basic illusions behind re-supplied by Agamben, Baumann and Holloway, is coming from zapatistic riots (we are you behind our masks) and is learning from its' own artistically practices. But it has to be understood as a gutsy, temporary rout not limited to national borders.

All these qualities have been coined and developed from a different mindset and frame of thought, culminating in *Bricolabs*, the collaborative narrative of individuals that investigate, exploit and prototype the loop of open source software, content, spectrum and hardware. Unlike Jens Kastner our trajectory to these qualities as a possible reality for 'uncapitalism' on a global level did not unravel itself through an investigation of the common denominators in the oppositional positions that have all claimed in some way or another the predominance of becoming/das Tun/anti-classification. Our trajectory to these qualities comes from the realisation that old and new technologies such as RFID, biometric identification schemes (gait recognition, intelligent tracking video cameras and on chip DNA testing), active sensor schemes in logistics, clothing, home - are in the process of creating a real world in which connectivities expand beyond our conscious schemes and protocols of interaction.

Overlaying our world of things with a digital veil already transcends space and time coordinates. A significant amount of technical, functional and conceptual expertise in this Internet of Things we find in the artistic practices of locative media artists, designers and hackers, expertise that is individually 'bought' and exploited by companies such as Nokia, Philips and others, expertise (that I argued in the May 2005 Space and Perception Conference at RIXC in Riga) should be gathered and exploited in "un-capitalist" formats and in notions of quality set by collaborative standards.

In a review of the August-September 2006 Waves Conference, also in RIXC, Riga I argued that two things were becoming painfully clear. First: the need to organise in some way or another is paramount as the pre-network schemes for influencing government and company policy through public debates and scandals no longer works as there is no more public in the network, only audience going from one daily scandal to another: either we assist policy to ensure that at least some public space survives, or we build our own parallel systems. And the second: while technology is becoming cheap, malleable and potent enough to create parallel infrastructures how do we organise the avant-garde conceptual power to be focused on real, concrete, discrete local and everyday objectives?⁵⁸

In the November 2006 Mobilfest Conference in Sao Paulo we were able to merge the arguments in claiming the possibility to go beyond an oppositional mode, to go beyond being against an ambient reality based on protocols of identification and classifications by outlining the possibility of private mesh networks as hardware has become both cheap and hackable. Mentioning Usman Haque, Bengt Sjolen and Adam Somlai Fisher working on Asus(brand) Wl-Hdd, wireless hard disk boxes and specifically Hivesnetwork.net whose project is to liberate embedded computers for artistic use, becoming a content structure, 'no longer only a connectivity structure through which access to the global internet is facilitated' we argued that the convergence of high-end EU projects like Hagggle (top-down opportunistic computing) and citizen designed networks like Hivenetworks (bottom-up opportunistic computing) is becoming real in its technological and scaling aspects and with it the real possibilities of creating parallel infrastructures. The intricate technical, functional and conceptual expertise in the artistic, design and hacking practices coincide with the philosophical and theoretical impossibilities to think oneself a way out on either categories of Sein/be or Tun/become/act:

"The material constitution of the we is the doing. On the one hand the doing is a practical negation, because it negates and changes. Moreover the doing is always a collective one, because even individual acting is based and set up on the doing of others Holloway speaks about (social) doing as a material base of forming the we or of identifying, to delimit it from ontological processes recurring on the being. However in contrast with a concept formation (or also community formation) the movement going back to the doing based on the being has to be understood as an antagonistic movement of identity and non-identity. The one who does [better the creator?] is and is not, just like the done [created] is and is not - non permanent objectified and then again integrated in the social flow. To think on a base of being means to identify.

Hello to the current Bricophonists, welcome. This is the first posting on the bricophonic list to say that in a couple of days we should receive a [... can't read this word] of a dutch foundation which encourages open source projects. This funds will allow the purchase of development kits, small electronic materials to reach a state of testing and to let run first drafts of code. We are not many persons on this list, because the project hasn't been published yet [not really sure about last half sentence] and to avoid that each one does not have anything to show again. Here are the base steps of our development.⁵⁹

Every new set of techniques brings forth its own literacy. The Socratic protests against introducing pencil writing, may seem rather incredible now, at the time it meant nothing less than a radical change in the structures of power distribution. Overnight a system of thought and set of grammar; an oral literacy dependant on a functionality of internal information visualization techniques and recall, was made redundant because the techniques could be externalised. Throughout Western civilization the history of memory externalisation runs parallel with the experienced disappearance of its artificial, man-made, character. An accidental disappearance, however much intrinsic to our experience, that up till now has not been deliberate.

The fundamental change that we are facing in pervasive computing and the converging

trend towards smart environments is the deliberate attempt of a technology to disappear as technology, becoming the very articulation and a priori of the space of flows, identifying, mapping, and pro-actively implying identities transposed into a hybrid grid of analogue and digital territories. This means that Sein-Tun holds no viable discriminatory opposition any more that gives the one more formative power than the other.

And mapped it is. The question is: can we flood the world with actual and conceptual ways of mapping creating layer over, taking away any notion of what is where with whom at what time whatsoever? Because we can not go home, I'm afraid.



FIGURE 8 | BRICOMEETING AT ENTER FESTIVAL, CAMBRIDGE 2007.

4. How to Act

A design for commoning, for living together locally in a globally connected world is the new challenge. For this to happen, policy needs to find new ways of presenting its data and information. Instead of talking about solidarity, it should talk about friendship. Instead of talking about profit, it should talk about sustainability. Instead of talking about sustainability, it should talk about the trades and the quality of work of artisans and small entrepreneurs. And the love they feel for their material. It should get rid of the essay, the report, the document. It should reduce the cycle of producing clear information for SME and lone entrepreneurs by adopting rapid prototyping and “demo or die” research strategies. It should plan, provide and pay for the infrastructure as broadband and wireless have become basic human rights, not outsource infrastructural demands to an open market.⁶⁰ It is therefore that the IP battles fought at this moment are so irrelevant for 21st century possibilities of economic policy agency.

Winners are those who can move away from the ideas of property rights and patents over things and licenses to adapt specific modules for services, as money making models. At the Contested Commons Conference (Sarai/CSDS, Delhi, January 2005) an impressive number of voices argued to go beyond Creative Commons (some rights reserved), as this way of operating leaves the fundamental notions of individual ownership and individual rights to specific ideas a person might conjure up, intact. Apart from the facts that the notion of ‘originality’ is a specific historic constellation - for in a networked world all nodes draw upon the same published data -, that this idea of being ‘the first’ in or with something is a specific western historic socio-cultural constellation as if this is of any matter in our over-mediated, globally-networked environment.

In *Evolution, Alienation and Gossip, The Role of Mobile Telecommunications in the 21st Century*, Kate Fox claims:

☐☐☐ “The space-age technology of mobile phones has allowed us to return to the more natural and humane communication patterns of pre-industrial society, when we lived in small, stable communities, and enjoyed frequent ‘grooming talk’ with a tightly integrated social network”.⁶¹

According to Fox, about two thirds of our conversation time is entirely devoted to social topics: “discussions of personal relationships and experiences; who is doing what with whom; who is ‘in’ and who is ‘out’ and why; how to deal with difficult social situations; the behaviour and relationships of friends, family and celebrities; our own problems with lovers, family, friends, colleagues and neighbours; the minutiae of everyday social life - in a word, gossip”.

This underlines the importance of the notion of enaction that Varela outlines in his study *Ethical Know-How: Action, Wisdom and Cognition*:

☐☐☐ “Enaction as the ability to negotiate embodied, everyday living in a world that is inseparable from our sensory-motor capacities”.⁶²

For him this notion is the key to understanding ethics in our everyday life. He wonders if the traditional way of setting up a cognitive set of ethical principles and axioms; you

should do this, you should not do that... is actually indicative of the way people behave when confronted with difficult decisions. What do you do, he asks, when you enter your office and you see your colleague tied up in what appears to be embarrassing telephone conversation? Would you not be very quiet and try to sneak out of the room unnoticed? Was that not an ethical decision that you made? And were you not immediately convinced that it was an embarrassing situation?

Varela then wonders if we possess a kind of ethical sense. A sense to negotiate encounters on a daily level. A networked, hybrid, world needs a notion of understanding, what does it mean when understanding takes places or happens. What are the criteria for its successful disappearing into local flow? What happens if you understand? When do you feel responsible for the implications of your understanding? When do you feel responsible enough to act? And suppose you feel responsible?

EDGES

We have seen the end of the guerilla, as being on the move now is not different anymore than staying in one place and securing it. At the outer ends of this kind of opposition we find the ultimate *innere Emigration* (inner emigration), the suicide of Menno ter Braak, four days after the Germans invaded the Netherlands, and Ted Kaczynski, the Unabomber. Menno ter Braak took sedatives and his brother gave him a lethal injection.

Drenched in the Nietzschean philosophy of autonomy and ever striving to be a *homme honnête*, he could – being involved in anti-fascist activities from mid-thirties – see the fascist logic of life very clearly and could not envision any way out. The *Innere Emigration* of intellectuals in the thirties, retreating into one's own mental sphere, not publishing, not speaking in public, was not only unbearable to him, he realized that it had become ontologically impossible. The Unabomber's strategy – killing three and maiming a further 23 – in trying to get his message across to both a research community and a larger public, has caused a lot of human suffering, landed him in jail and may have had adverse effects in that the search for him converged new techniques of surveillance. In the end it was his brother that recognised his style.

As a core issue in his thinking is his distinction between small-scale technology is technology “that can be used by small-scale communities without outside assistance” and organization-dependent technology is technology that depends on large-scale social organization”.

According to him, there are no significant cases of regression in small-scale technology, “but organization-dependent technology does regress when the social organization on which it depends breaks down. His two major assumptions though are very true, the first being that “that if the use of a new item of technology is initially optional, it does not necessarily remain optional, because the new technology tends to change society in such a way that it becomes difficult or impossible for an individual to function without using that technology”.

The second that he foresees that the system may break down and if it does break down “the consequences will still be very painful. But the bigger the system grows the more disastrous the results of its breakdown will be. So if it is to break down it had best break down sooner rather than later”. If it breaks down “there may be a period of chaos, a “time of troubles”. It would be impossible to predict what would emerge from such a time of troubles, but at any rate the human race would be given a new chance.

Most importantly he did not care for socio-cultural or societal arguments. He makes

it very clear that “this is not to be a *political* revolution. Its object will be to overthrow not governments, but the economic and technological basis of the present society”. He therefore advocates “a revolution against the industrial system”. Realizing that it cannot be only stick, he needs a carrot too if he wants followers. His positive ideal “is Nature. That is, *wild* nature; those aspects of the functioning of the Earth and its living things that are independent of human management and free of human interference and control”. And that is exactly the moment where he becomes a historical position himself, as in 2008 there is only Next (manipulated/user generated/enhanced) Nature left, the notion of Climate Exchange haunting us in any metaphor or real location.

In the year 2000, 47 percent of the world’s population lived in cities. In 2030, 60 percent of the world’s population will live in an urban environment. The growth will occur in less developed countries, especially in coastal South Asia. More than 58 cities will boast populations of more than five million people.⁶³ One of these cities will be the aforementioned Song Do City, an “ambient city”, in which all “information systems (residential, medical, business, governmental, etc.) share data, and computers are to be built into the houses, streets and office buildings”. The city itself will exemplify a digital way of life, the “U-life”. This is a city of control.

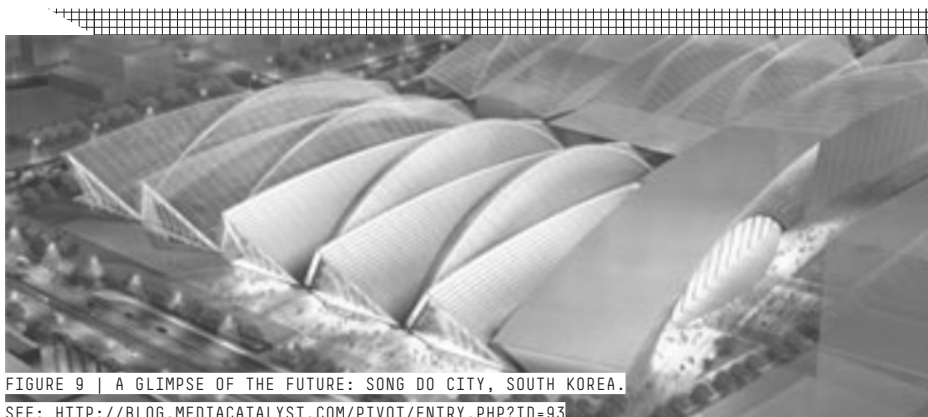

FIGURE 9 | A GLIMPSE OF THE FUTURE: SONG DO CITY, SOUTH KOREA.

SEE: [HTTP://BLOG.MEDIACATALYST.COM/PIVOT/ENTRY.PHP?ID=93](http://blog.mediacatalyst.com/pivot/entry.php?id=93)

At the other end of Song Do, we find cities that have imploded under corporate robbery and tribal violence. This is a feral city:

“Imagine a great metropolis covering hundreds of square miles. Once a vital component in a national economy, this sprawling urban environment is now a vast collection of blighted buildings, an immense Petri dish of both ancient and new diseases, a territory where the rule of law has long been replaced by near anarchy in which the only security available is that which is attained through brute power. Such cities have been routinely imagined in apocalyptic movies and in certain science-fiction genres, where they are often portrayed as gigantic versions of T. S. Eliot’s *Rat’s Alley*. Yet this city would still be globally connected. It would possess at least a modicum of commercial linkages, and some of its inhabitants would have access to the world’s most modern communication”.⁶⁴

In between we find the city of trust. It is not there yet. We have to build it. It takes off from the realisation that in a networked world small-scale open content, software and hardware - made for and used by artisans - does not have to remain physically local but can travel through friends across the world. Here the two modes of opposition are exemplified by Katherine Albrecht (privacy activist at CASPIAN and co-author of *Spychips*) and Melanie Rieback (researcher at the Vrije Universiteit in Amsterdam). Melanie wrote the RFID virus and made an RFID Guardian⁶⁵ – a tool that allows you to block some tags and accept others – showing that privacy by design is not only culturally and socially productive but business wise fostering privacy as a unique selling point.

The RFID Guardian is a small scale tool that can help us organise our privacy settings ourselves provided we will have an open source infrastructure and negotiated privacy policies (my settings on RFID reader enhanced phone guide me through stores and the supermarket).

Katherine Albrecht⁶⁶ took the lead as an expert on consumer privacy in unearthing numerous dubious patents on RFID, and expressing her concerns about the lack of an ethical framework in consumer tracing and tracking. In our discussions throughout the years, we realized we both were looking at more than a logistics operation, but a technological paradigm shift that we felt was coming dangerously close to our souls.

To my soul, it feels as if the very space that is pregnant with meaning, with poetry, with love, is being filled up with binaries that look at me as a set of qualities, no longer human, as in celebrating my messiness, the in-betweens, all these prolonged moments in which action takes not place. Maybe the city of trust lies in these.

TRUST, MISTRUST AND INFORMATION

I have borrowed the entire story of Lequeux, Lord Northcliffe and Colonel Edmonds from Philip Knightley who describes it in his book *The Second Oldest Profession: The Spy as Bureaucrat, Patriot, Fantasist and Whore*.⁶⁷

By 1906 author William Lequeux, who believed that Germany had at least five thousand spies in England, had succeeded in talking Field Marshal Lord Roberts into co-writing a fictionalised account of the German invasion to be serialised in the Daily Mail. Lord Northcliffe, the owner of the newspaper was not pleased with the tour they planned as it took the Germans through areas where the Daily Mail was hardly read. Northcliffe personally re-routed the invading army. The publication was a huge success. Even when published as a book 'The Invasion of 1910' sold more than one million copies.

When Colonel James Edmonds, head of military counter intelligence, speaking before a sub-committee of the Committee of Imperial Defence on Tuesday, March 30 1909, tried to persuade its members to allocate him more than the £200 and two assistants that had been assigned to him, he was speaking to a very sympathetic audience that desperately wanted him to provide them with the proof that would justify their suspicions that England was riddled with German spies. But Colonel Edmonds had nothing more than hearsay and newspaper-clippings to offer. To his rescue came William Tufnell Lequeux.

In 1909, William Le Queux published *Spies of the Kaiser: Plotting the Downfall of England* which was "based on serious fact within my own personal knowledge". Thousands of readers considered it – "as they had every right to do in view of Lequeux's ambiguous presentation of the book as fact in fictional form" as being totally true. A

wave of spy fever swept over the country. Readers sent letters to Lequeux in which they reported incidents that mirror the cases he presents in his book. This in turn reinforced his own views – so many people observing the same suspicious behavior as him.

And these letters he presented as new evidence to Colonel Edmonds who in turn prepared them as a catalogue of ‘Cases of Alleged German Espionage’ and presented them to the second meeting of the sub- committee of the Committee of Imperial Defense on April 20, 1909. The most interesting thing about this catalog of ‘Cases of Alleged German Espionage’ is that Lequeux’s cases – the cases he presented in his novel – are, as Knightley writes, easily identifiable.

The sub-committee of the Committee of Imperial Defence was taken aback by the massive penetration of England by German spies and voted to fund the Secret Service, the first modern espionage service ever. Only one agent of the twenty-one spies the British arrested on 4 August 1914, when Germany declared war on America, was ever brought to trial.

What’s fact, what’s fiction? What is real? What is not real? What is data? What is not? Real to whom? Does it matter?

But, one might say, what can be more real than facts? To answer that we have to turn to Mrs. Oliphant, 19th century influential novelist and critic. She says:

“Facts are of all things in the world the most false to nature, the most opposed to experience, the most contradictory of all the grand laws of existence... for us truth and fact are two different things; and to say that some incident which is false to nature is taken from the life is an altogether unsatisfactory and inadmissible excuse”.⁶⁸

This is ontologically quite puzzling until you realize that the key word here is ‘for us’. ‘Us’ is the set of protocols that can decide what the grand laws of existence are. ‘Us’ is vested interests. ‘Us’ is capitalism. From raw violence and naked power it has dressed itself up in past centuries in various disguises, the last one being the shameful charade of a democracy we are being told we live in.

The same mechanisms are going on at the moment; our Lequeuxs may have different names. The red herring might have a different color. A bomb may explode somewhere. So? Is the suffering caused by that bomb lessened by spending £1bn more on security reforms than the current annual spending (2007) and a tripling of funding since the 9/11 attacks on the United States?⁶⁹ Will it stop others? And even if it would stop one, does that justify installing distrust and fear as the default? On the basis of some vague clues Belgium upped its alert at Christmas 2007. All security agencies have asked and received a larger budget to counter these alleged threats, raising it collectively to 130 million euro for 2008. These are not adequate responses.

Security reforms

In the wake of the 9/11 attacks the government began raising national security spending, taking it to approximately £3bn by this year.

Shortly after becoming prime minister, Mr Brown said there would be a new Office for Security and Counter-Terrorism co-ordinating efforts across government and the various security agencies.

HOME OFFICE EXTRA CASH

- + 2008-09: £546m
- + 2009-10: £728m
- + 2010-11: £1.1bn

Source: Comprehensive Spending Review

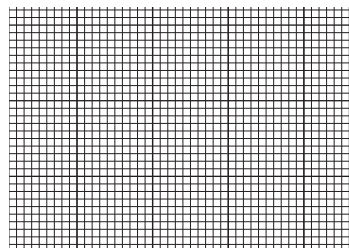

ADEQUATE RESPONSE

In WWII the Germans – in an attempt to confuse the Allied pilots – covered large areas with nets or painted wooden structures. One night one single RAF plane flew over the ‘village’ and dropped one wooden bomb.⁷⁰

I WILL GO WALKING

*“And when public space disappears, so does the body, as (...) adequate for getting around”.*⁷¹

It was, as some Parisians later claimed, a perfect afternoon for a stroll in the Tuileries. Finally managing to escape the oppressive indoor drudgery to which they had been confined for so long, if not the whole of Paris, than certainly a specific political cross-section of the Parisians, welcomed this sunny January afternoon with a ferocity normally reserved for their traditional afternoon apéritif. The Jardin des Tuileries had always been, as it was to remain, a popular resort and few people could resist the temptation to walk past the Jeu de Paume towards the Place de la Concorde to go for a café at the Champs Elysées for although it was sunny, it was still bitterly cold. They could still gaze upon the Tuileries Palace, built by Catharina de Medici in the 16th century, it was not to survive the year 1871 when it was thoroughly plundered and destroyed by the Communards.

But now it stood firm testimony to the power of Kings and Queens over their subjects. A monarchical power that was, in the shape of Napoleon III, making a desperate attempt to survive by transforming an authoritarian Empire into a liberal one, a tactical move, which, as we know, did not succeed and led to the proclamation of the Republic on September 4, 1870.

But to the people who strolled on the Champs-Elysées that fateful January afternoon, this was still the Second Empire and they made no conscious connection between the amazing spectacle they were about to witness and the political earthquake that lay only a few months ahead.

A few weeks earlier, on January 10, 1870, Victor Noire, a journalist from the extreme republican newspaper *La Lanterne*, was killed by Pierre Bonaparte, the Emperor’s cousin. This event profoundly disturbed the ‘eternal’ conspirator Blanqui whose revolutionary republican activism had earned him a wide range of dedicated followers. He suddenly realised that he only knew his lieutenants personally, and had never actually seen the men they commanded in his name. In effect, he did not even know their exact number.

Desperately wanting to assess the strength of his troops personally, he contacted his aide-de-camp.

The problem was obvious. They could not organise a parade of revolutionaries as if it were a regular military army. The solution, however, was equally obvious. You can hide a parade of revolutionaries in a parade of afternoon strollers.

He said farewell to his sister, put a gun in his pocket and took up his post on the Champs-Elysées. There the parade of the troops of which he was the mysterious general would take place. He knew the officers, now he would see the men they led for the first time, marching past in proud display. Blanqui mustered his troops for inspection without anyone suspecting anything of what was actually happening. In the crowd that

watched this curious display Le Vieux stood leaning against a tree watching his friends silently approaching in columns. The promenade was momentarily transformed into a parade ground.

In the very act of moving, walking men became marching soldiers.

Marching soldiers only had to drop out of line back into the crowd to be transformed into walking men again and ultimately into afternoon strollers on a sunny January afternoon. The Blanqui parade dispersed as swiftly as it had emerged. The unsuspecting onlookers were left with their bewilderment, in doubt as to what they had actually seen. They had witnessed a powerful manifestation of the existence of an another 'society' that had no institutional place in the political organisation of their time.

The covert world represented by the Blanqui parade erupted for a brief moment in the overt world at a time and place when it was least expected. In that brief moment, its presence deliberately unmasked, the covert parade coexisted alongside the overt promenade, and it is hard to tell which was the more real as the physical acts of strolling and marching seemed to blend into an harmonious simultaneity, thus revealing the frightening prospect that they might be interchangeable.

In the blurring of the boundaries between marching and walking we are made aware of how we are positioned within a field of vision and that we might able to construct meaning through experiencing the transgression itself. At the same time, however, experiencing the transgression strengthens our notions of the very acts themselves, we translate the momentary – the simultaneous blending - into our everyday notions of walking and marching.

In the very moment that we gain the opportunity to make sense, we lose the opportunity to integrate it fully into our own ways of seeing.

TRANSCENDING OPPOSITIONS: WHAT DOES IT MEAN?

During the October 2007 Conference *Recalling RFID*, that was curated by Richard de Boer from de Balie, Sabine Niederer from INC and yours truly, I noticed a man sitting next to me heavily sighing during the debate between Katherine Albrecht and Bart Schermer, the speaker for RFID Platform Netherlands. This organisation aims to push RFID through its logistics stage towards a broader acceptance by consumers. He turned out to be Hein Gorter de Vries, strategic director of GS1 Netherlands. According to its website, GS1 “proactively supports the implementation of global GS1 standards and collaboration concepts in order to achieve greater value chain efficiency and/or quality”.⁷²

I invited him to the speakers' dinner, during which he and Katherine Albrecht did not exactly become friends, although both established a base for general communication. That, after all, had been the intention of the Conference, to get the main speakers in their respective fields to debate with each other and to design a framework where the other main positions on security, privacy, consumer applications, design and infrastructure, could tell the most comprehensive story possible.

After the Conference I set up a mailing list that has subsequently grown. Now as many as 46 members enjoy a bimonthly meeting at either the Waag Society in Amsterdam or the A+R RFID Lab in Den Haag. The group is named DIFR⁷³, and seeks nothing less than an alternative way at looking at RFID. At its heart lies something I describe as the “trust paradox”. The paradox asks this question: how can we design our way out of a situation

where people need to trust the environment in order for Ambient intelligence to deliver what it promises, while they are being told at the same time that they cannot trust that environment?

The members range from the group of Radboud Nijmegen, who hacked and cloned the Mifare card; Jaap Henk Hoepman; Tijmen Wisman from RFID Platform; Yolande Kolstee from KABK (AR+RFID Lab), Hein Gorter de Vries from GS1, Ben Schouten of Fontys Ambient intelligence; Christian van 't Hof from Rathenau Institute, Pieter Rotteveel from Medialab Amsterdam, and Paul Geurts from *Hello My Name is E* (an application for swapping business cards). In short: an assembly of a group who between them hold all the crucial positions on RFID.

Vital for the success of such a network is the existence of a network of independent spaces that are not originating emanating from a university (which in my opinion remain too restricted by its traditional output of research papers and PHDs), nor from a companies (which clearly betray conflicts of interests) or a government (too many different agenda's within different ministries) or individuals (can not guarantee continuity).

In Holland the only place that could host such a network is Waag Society,⁷⁴ a media lab that has grown out of the Digital City and Hacktic in the nineties, concerned then with Public Domain on the Internet. Now the society is concerned with Public Domain in the Internet of Things, and as such has a lot of professional expertise in how to connect and frame the differences and oppositions. Most importantly it is a space is able to bring the outer ends of the spectrum; the hackers and the industry together. In 2005 Gill Wildman (Plot) and I hosted a relatively successful seminar on RFID at the Design Council in London which we titled the *The Elephant in the Room: Bringing Innovation into RFID Applications*. We talked about how there was no no doubt that RFID has the potential to be a paradigm-shifting technology, we stated and everyone is pleased when they get the technology to work, and that is difficult enough, but they are not building into the pilots the human dimensions that could make the pilots beneficial in a wider way.

I focused on moving *from privacy to privacies*, which acknowledged that in a hybrid environment we leave different traces and might want to build temporary personalities around these traces, not exposing our entire personality all the time. One of the concrete applications we focused on one the idea of having privacy levels on your mobile phone, as we guessed it would have an RFID reader soon. In industry terms you would have a lifestyle manager, in privacy activist terms you would have the equivalent of Melanie Rieback's RFID Guardian – a firewall.

In DIFR we are seeing the first real implementations of looking at RFID from the perspective of citizen empowerment. Using the RFID Guardian, the Radboud vision on revocability and ideas from Moboubiq and foremost from Christian van 't Hof as real and mental models of allowing certain tags to pass and blocking others we can negotiate with the standard organizations and the people who run logistics, pilots in open infrastructures: A consumer sets his privacy preferences in a profile stored on his mobile phone. If he holds the phone close to a product in a shop containing an RFID tag, the phone will read the tag number from the tag. It will then query (over the Internet, either through GPRS, UMTS or WiFi) the backoffice to retrieve the privacy policy corresponding to the tag number. It will then match the tag policy with the consumer policy, and present the result of the match to the consumer on the display of the mobile phone in an intuitive and appealing manner.⁷⁵

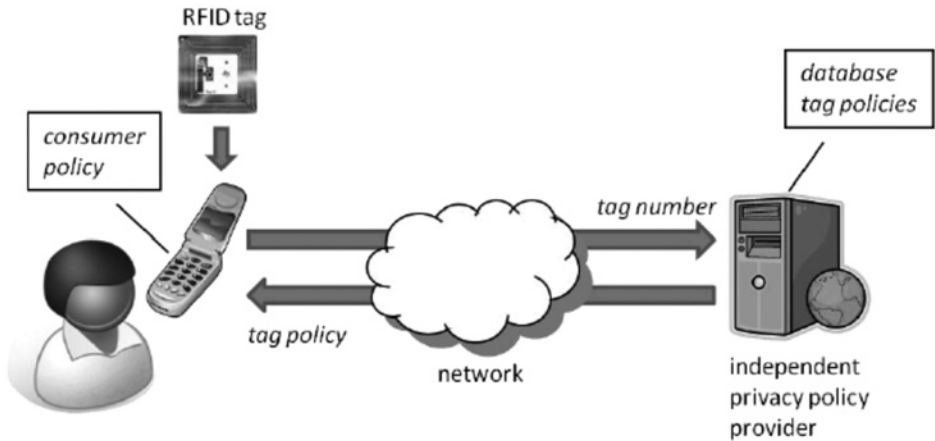

FIGURE 11 | HOW IT ALL WORKS: A MODEL FOR RFID CREATED BY THE DIFR GROUP

NEGOTIABILITY AS A STRATEGY.

So what if it is not too late?

What would happen if we focus on the cracks within the systems of control, or bypass them and direct all our energies on negotiating with our own coding power and architectural intelligence, not only making it less pernicious, but as a tool for us to use? What if we really start to focus on creating an open – and open source – infrastructure within the whole radio frequency range, from the local near field communication (NFC) to the Global Positioning System (GPS)?

The only way towards a City of Trust is to start locally. We will never know if we do not start with our own houses, friends, streets and villages.

I've got my window open wide.⁷⁶

Tilburg 1988 - Ghent, July 5, 2008

REFERENCES

- 1 | See: <http://www.i3net.org/>
- 2 | *The Disappearing Computer* (DC) is the name of a recent proactive initiative launched by *Future and Emerging Technology* (FET) within the European IST programme. http://www.i3net.org/ser_pub/services/dc/
- 3 | In order to make this experience productive (read: make it politically viable and socially constructive) in order to find ways of transmitting, ways of teaching experiences like this - we textualise them. We find analogies; we read initial lines as metaphor, as metonymy.
- 4 | Or pervasive computing, or ubicomp, ubiquitous computing, calm technology, disappearing computer, basically all (although for the experts there are intricacies) pointing at an infusion of sensor technology in the environment, making it smart as in smart textiles, smart homes, smart cars etc.
- 5 | Mark Weiser, 'The Computer for the Twenty-First Century', *Scientific American* (September 1991), p. 94-10.
- 6 | Manuel De Landa, *A Thousand Years of Non-Linear History*, New York: Zone Books, 1997, p. 51.
- 7 | "Intelligent biomedical clothes could benefit a wide range of people: People who just want to stay fit and healthy; healthy people who know they are at risk of developing specific illnesses but want to remain healthy; chronically ill patients by helping them manage their condition effectively; and vulnerable people, such as the elderly, by enabling them to live as independently as possible, for as long as possible, outside traditional care institutions". <http://www.ehealthnews.eu/content/view/339/27/>
- 8 | "Philips recently presented two prototypes from their SKIN project. "Frison" contains LEDs which responds to breath and air movement upon the body. "Bubelle" senses emotive information, and reacts differently to each individual. The concept behind these experimental garments is to research the expression of emotion and personality through reactive wearable technology, using Philips expertise in lighting innovations". http://www.popgadget.net/2006/09/glowing_wearabl.php
- 9 | City Slikkers is a Pervasive Game (alternatively Location-based game), which takes place in the real-existing city. It is designed to connect a large number of players throughout the world and change the way the surroundings are seen. The central idea behind the concept is to give people the opportunity to symbolically interfere with the everyday urban environment and come into contact with previously unknown people". <http://cityslikkers.com/>
- 10 | "OnStar will soon include the ability for the police to shut off your engine remotely. Buses are getting the same capability, in case terrorists want to re-enact the movie Speed. The Pentagon wants a kill switch installed on airplanes, and is worried about potential enemies installing kill switches on their own equipment. Microsoft is doing some of the most creative thinking along these lines, with something it's calling "Digital Manners Policies". According to its patent application, DMP-enabled devices would accept broadcast "orders" limiting capabilities. Cell phones could be remotely set to vibrate mode in restaurants and concert halls, and be turned off on airplanes and in hospitals. Cameras could be prohibited from taking pictures in locker rooms and museums, and recording equipment could be disabled in theatres. Professors finally could prevent students from texting one another during class. This is really about media companies wanting to exert their control further over your electronics. They not only want to prevent you from surreptitiously recording movies and concerts, they want your new television to enforce good "manners" on your computer, and not allow it to record any programs. They want your iPod to politely refuse to copy music to a computer other than your own. They want to enforce their legislated definition of manners: to control what you do and when you do it, and to charge you repeatedly for the privilege whenever possible. Digital Manners Policies" is a marketing term. Let's call this what it really is: Selective Device Jamming. It's not polite, it's dangerous. It won't make anyone more secure - or more polite". *I've Seen the Future, and It Has a Kill Switch*, Bruce Schneier, e-mail commentary, June 26, 2008. http://www.wired.com/politics/security/commentary/securitymatters/2008/06/securitymatters_0626
- 11 | Bruce Schneier, 'The ID Chip You Don't Want in Your Passport', *Washington Post*, September 16, 2006, p. A2.
- 12 | Timo Arnall: "Nokia is attempting to focus on features such as sharing content through touch-interactions and using tags as a way of controlling phone functions". <http://www.nearfield.org/2008/05/thoughts-on-nokias-nfc-developments>
- 13 | "On September 29, 2006, Koninklijke Philips Electronics N.V. (Philips) sold 80.1% of its semiconductor businesses to a consortium of private equity investors in a multi-step transaction, consisting of Kohlberg Kravis Roberts & Co. (KKR), Bain Capital, Silver Lake Partners, Apax and Alpinvest Partners N.V., while Philips retained 19.9% of our shares". <http://www.nxp.com/investor/>
- 14 | December 15, 2007 - Updated 0354 GMT (1154 HKT) Four Bolivian regions declare autonomy from government From Helena DeMoura CNN: "Tensions were rising in Bolivia on Saturday as members of the country's four highest natural gas-producing regions declared autonomy from the central government". <http://edition.cnn.com/2007/WORLD/americas/12/15/bolivia.unrest/>
- 15 | *Cultural Information and Research Centres Liaison in Europe* is an independent think-tank dedicated to developing cultural policy models for Europe. <http://www.circle-network.jaaz.pl/>
- 16 | Rob van Kranenburg, 'Whose Gramsci? Right-wing Gramscism', *International Gramsci Society Newsletter* Nr. 9 (March, 1999), p. 14-18.
- 17 | It was translated into Russian by Kirill Razlogov, Director of the Russian Institute for Cultural Research. Kazimierz Krzysztofek invited me to Krynica, Eastern European Forum.
- 18 | See: <http://www.nrc.nl/binnenland/article326188.ece>
- 19 | Alphonse de Lamartine, *History of the French Revolution of 1848*, London:1849, (translated from French), p. 3.
- 20 | In Café Libre, directly opposite Carnaby Street, London, there are four cameras on the ceiling and nobody seems to mind.

- 21 | "Twenty years ago, repair manuals for certain cars were 100 or so pages long. Now, they hold over 1 million pages and are available only electronically, says John Paul, who handles repair-shop certification for AAA Southern New England". <http://www.csmonitor.com/2004/0419/p13s02-wmgn.html>
- 22 | Auto Mechanics Fight for 'Right to Repair'. Why It May Not Be Your Local Shop's Fault That They Can't Fix Your Car by Tom Peter. ABC News, April 27, 2008. <http://abcnews.go.com/Business/CSM/story?id=4728747&page=1>
- 23 | From: Dewayne Hendricks dewayne@warpspeed.com | January 16, 2003. *Consumer Products: When Software Bugs Bite*, by Debbie Gage http://www.baselinemag.com/print_article/0,3668,a=35839,00.asp
- 24 | *IDrive in crazy mode*, Roadfly photo gallery: <http://www.roadfly.org/bmw/gallery/picture.php?path=25876,1:25871,1:-43,1>.
- 25 | The pencil, the gramophone, the telephone, the CD player, technology that was around when we grew up, is not technology to us, it is simply another layer of connectivity. Ephemerisation is the process where technologies are being turned into functional literacies; on the level of their grammar, however, there is very little coordination in their disappearing acts. These technologies disappear as technology because we cannot see them as something we have to master, to learn, to study. They seem to be a given. Their interface is so intuitive, so tailored to specific tasks, that they seem natural. In this we resemble the primitive man of Ortega y Gasset: "(...) the type of man dominant to-day is a primitive one, a Naturmensch rising up in the midst of a civilised world. The world is a civilised one, its inhabitant is not: he does not see the civilisation of the world around him, but he uses it as if it were a natural force. The new man wants his motor-car, and enjoys it, but he believes that it is the spontaneous fruit of an Edenic tree. In the depths of his soul he is unaware of the artificial, almost incredible, character of civilisation, and does not extend his enthusiasm for the instruments to the principles which make them possible". This unawareness of the artificial, almost incredible, character of Techné – the Socratic term for technique, skill – is only then broken when it fails us: "Central London was brought to a standstill in the rush hour on July 25, 2002, when 800 sets of traffic lights failed at the same time – in effect locking signals on red". Every new set of techniques brings forth its own literacy. The Socratic protests against the introduction of writing with pencils, may seem rather incredible now, at the time it meant nothing less than a radical change in the structures of power distribution. Overnight, a system of thought and set of grammar; an oral literacy dependant on a functionality of internal information visualization techniques and recall, was made redundant because the techniques could be externalised. Throughout Western civilization the history of memory externalisation runs parallel with the experienced disappearance of its artificial, man made, character. An accidental disappearance, however much intrinsic to our experience, that up till now has not been deliberate: "The most profound technologies are those that disappear. They weave themselves into the fabric of everyday life until they are indistinguishable from it".
- 26 | <http://oxossi.metareciclagem.org/>
- 27 | This is a term by Bronac Ferran.
- 28 | Felipe Fonseca is a Brazilian independent researcher working in the fields of technological appropriation, free culture and multimedia production. He has been an advisor for the Brazilian Pontos de Cultura project, that has created hundreds of multimedia centers based on free and open source technology. Felipe is a member of the consulting board of the distributed organization DesCentro and one of the founders of the Brazilian MetaReciclagem network.
- 29 | <http://www.bricolabs.net/> and <http://lists.dyne.org/mailman/listinfo/brico>.
- 30 | From: felipefonseca@gmail.com
Subject: Re: first draft Date: Tue 23 Jan 2007 05:30:47 GMT+01:00
To: bronacferran@googlegmail.com
Cc: kranenbu@xs4all.nl
<http://www.pataphysics-lab.com/sarcophaga/manyfestos/de%20Andrade,%20Oswald%20-%20Cannibal%20Manifesto.html> and also comments here: http://www.itaucultural.org.br/aplicExternas/enciclopedia_IC/index.cfm?fuseaction=marcos_texto_ing&cd_verbete=4110
<http://en.wikipedia.org/wiki/Tropicalia>
- 31 | <http://www.songdo.com/>
- 32 | "Anthony Townsend, from Taub Urban Research Center, has been asked by the South Korean government to "turn an undeveloped parcel of land on the outskirts of Seoul into a city whose raison d'être will be to produce and consume products and services based on new digital technologies. "The main challenge lies in the realization that "half of designing a city is going to be Information spaces that accompany it because lots of people will use this to navigate around". Waiting rooms, he claims, become something of an anachronism because no one really waits anymore. Townsend claims that telecommunications in a city in 2012 is going to be a lot more complex: "The most interesting thing about it will be that you won't be able to see it all at once because all these data structures, computational devices, digital networks and cyberspaces that are built upon those components will be invisible unless you have the password or unless you are a member of the group that is permitted to see them". Sandeep Junnarkar, Designing the Century's First Digital City, September 18, 2002. <http://news.com.com/2008-1082-958461.html>
- 33 | The repercussion of this is that on top of the global TCP/IP protocol of the internet, we now find the search for an equally productive protocol of the internet of things. This will be the battle in the coming decade, in whose language will things talk to each other, to their representations in the database, and how will they be digested by the algorithms?
- 34 | 'Heineken, IBM, Safmarine and University of Amsterdam Launch Wireless "Beer Living Lab"'. http://findarticles.com/p/articles/mi_pwwj/is_200610/ai_n16809752/print?tag=artBody;col1
- 35 | See: <http://mutirao.metareciclagem.org/taxonomy/term/56>
MetaReciclagem FAQ (English) | Submitted by felipefonseca on Wed, 15/03/2006 - 19:46. | Permalink: <http://metareciclagem.org/drupal/livro/metarecicla...> | Autor (a): Felipe Fonseca, Ian Lawrence | What is MetaReciclagem

- 36 | See: <http://www.boundaryobject.org/id4.html>
- 37 | February 6, 2007: "Hello Felipe - I'd like to introduce you to Matt (Ratto) who is the social scientist (based currently in the Netherlands) who was mentioned in one of the versions of the proposal to the Dutch Embassy. He has been working, simultaneously, on ideas related to generic infrastructure and also to how technological development happens so he and Rob are going to sit down for a coffee tomorrow. Matt has seen some versions of the Bricolabs papers and I thought I should also introduce you so he can test out some of his thoughts directly with you. He's keen to somehow connect...
bests
Bronac"
- 38 | Matt Ratto is Assistant Professor in the Faculty of Information Studies at the University of Toronto at Critical Making lab.
<http://www.criticalmaking.com>
- 39 | Venzha Christiawan has been focusing on new media art since 1999. Established the "House of Natural Fiber" (Yogyakarta new media art laboratory), and produced and organized projects related to new media and education. Some of his works and projects have been presented in Japan, Singapore, Malaysia, France, Brazil, Netherlands, Germany, and Finland. <http://www.natural-fiber.com>
- 40 | On Fri, Dec 15, 2006 at 11:28:45PM +0100, Rob van Kranenburg wrote:
Hi Jaromil,
As you can see we (Felipe F, Bronac Ferran, me) took the liberty to include you in our plans. Hope this is ok, very ok! thanks :)
at which time you'd like to meet today regarding OV kart?
ciao!
- 41 | Denis "Jaromil" Rojo is author of the liveCD dyne:bolic GNU/Linux and software as Hascicam, MuSE and Freej, for running a web radio and for vejay and realtime video manipulation. He is active on Open Source Research & Development for the Netherlands Media Art Institute and as a developer for the dyne.org free software foundry. His productions are available on <http://jaromil.dyne.org>.
- 42 | Where: Mains des Oeuvres, Rue Charles Garnier. The Rue leading up to the venue is le Rue Blanqui. Who: Participants: Denis Jaromil Rojo, Venzha Christiawan, Rob van Kranenburg, Jean-Noël Montagné, Benoit Campo, Aude Ghilbert, Wassily Kosinetz, Maël Primet, Marie-Anna Tsagouris, Marion Louisgrand, Joe Holmberg, Veronika Benova, Kamon Ayeva.
- 43 | See: chapter 2.
- 44 | Doron S. Ben-Atar, *Trade Secrets: Intellectual Piracy and the Origins of American Industrial Power*. New Haven: Yale University Press, 2004.
- 45 | "MetaReciclagem is an open network created in 2002 in Brazil. It has been the result of intensive exchange through the internet of over a hundred people from different sectors in a mailing list. At first a collective in São Paulo proposing the reuse of donated electronic equipment with free and open source software, soon MetaReciclagem turned into a network of multiple identities working towards the deconstruction of technology, taken in a broad sense, and its re-purposing and re-signification in different contexts aiming at social change. While opting not to follow the common path in Brazil - creating an NGO and earning lots of money from the government by repeating the same practices over and over again-, MetaReciclagem has established distributed and deep dialog with projects in the government and civil society, universities and businesses, proposing a participatory approach to collaborative exchange between people and institutions. Members of MetaReciclagem have been, in an emergent way, an important influence to plenty of Brazilian projects related to subjects such as digital inclusion and technological appropriation; free and open source software, knowledge and culture; media and technological education; open innovation networks and media arts; and many others". Unesco. Success story's <http://www.unesco-ci.org/cgi-bin/ifapstories/page.cgi?g-Detailed%2F32.html;d=1>
- 46 | See: http://www.hivenetworks.net/tiki-index.php?page_ref_id=37.
- 47 | Rebecca Empson (ed.), *Thinking Through Things, Visions of the Future: Time, Causality and Prophecy in the Mongolian Cultural Region*, Inner Asia Monograph Series, Kent: Global Oriental / University of Hawaii Press, 2006, p. 113-135.
- 48 | Alfred Gell, *Art and Agency: An Anthropological Theory*, Oxford: Oxford University Press, 2008
- 49 | <http://web.media.mit.edu/~amerigo/alt-499-bonanni.pdf>
- 50 | Ortega y Gasset, *Jose The Revolt and the Masses*, New York: Norton & Company, 1932 (translation from Spanish).
- 51 | Both projects initiated by Jean Noël Montagné of Craslab Paris and Bricolabs.
- 52 | <http://www.craslab.org/bricophone/>
- 53 | "Bonjour aux bricophonistes actuels ou à venir. Ce premier post sur la liste Bricophone pour dire que nous devrions recevoir dans les prochains jours un mécénat d'une fondation néerlandaise, qui subventionne des projets open source. Ces fonds permettront de financer les achats de kits de développements, petits matériels électronique pour monter la plateforme de test et de lancer de premiers travaux de code. Nous ne sommes pas nombreux sur cette liste, car il n'y a pas eu encore de publicisation du projet, vu qu'on a encore rien à montrer. Voici les grossières étapes de notre développement: (il y a beaucoup plus sur cette page. See: <http://www.craslab.org/bricophone/?page=WhitePaper>)"
- 54 | <http://www.nlnet.nl/project/bricophone/>
- 55 | Steve Cisler commented: "I can guess at the content of Kastner's book from your brief description, but the term in English is used almost exclusively by homeland security types to describe terrorist groups, especially al Qaeda which, according to Frank C. Urbancic, Acting Coordinator for Counterterrorism, 'openly describes itself as transnational guerilla' operation. And the Zapatistas are 14 years later quite marginalized and quiet in Mexico. It's also used to label purely criminal groups like the Mara Salvatrucha (Honduran/El Salvador gangs which have come back to the U.S. and other central American countries)".
- 56 | Kastner, Jens, *Transnationale Guerilla*, Unrast Verlag, 2007, p.4.

- 57 | Joseph Pugliese, 'Biometrics, Infrastructural Whiteness and the Zero Degree of Non-Representation' *Boundary 2* (Duke University Press), 34.2 (2007): 105-133.
- 58 | "It is common to see examples that attempt to show that the IPv6 address space is extremely large. For example, IPv6 supports 2128 (about 3.4×10^{38}) addresses, or approximately 5×10^{28} addresses for each of the roughly 6.5 billion (6.5×10^9) people alive today. In a different perspective, this is 252 addresses for every star in the known universe— more than ten billion billion billion times as many addresses as IPv4 supported". <http://en.wikipedia.org/wiki/IPv6>
- 59 | See also my articles 'When Wireless Dreams Come True', *Mute* October 5, 2006, <http://www.metamute.org/en/When-Wireless-Dreams-Come-True>, 'How To: The Will to Organize', *Leonardo* 39: 4 (August 2006), p. 319-321, and: Notions on Policy in Eastern Asia—Europe Media Spaces, *Leonardo* 39:4 (August 2006), p. 305-309.
- 60 | There is a lot more on this page: <http://www.craslab.org/bricophone/?page=WhitePaper>.
- 61 | Kate Fox, *Evolution, Alienation and Gossip: The Role of Mobile Telecommunications in the 21st Century*, SIRC, 2001. <http://www.sirc.org/publik/gossip.shtml>
- 62 | Francisco J. Varela, *Ethical Know-How, Action, Wisdom and Cognition*, Stanford, California: Stanford University Press, 1992, p. 17.
- 63 | Stanley D. Brunn, Jack F. Williams, and Donald J. Zeigler (eds.), *Cities of the World: World Regional Urban Development*, New York, NY: Rowman & Littlefield Publishers Inc., (2003).
- 64 | Richard J. Norton, 'Feral cities - The New Strategic Environment', *Naval War College Review*, Autumn (2003). http://findarticles.com/p/articles/mi_m01W/is_4_56/ai_110458726
- 65 | http://www.rfidguardian.org/index.php/Main_Page
- 66 | <http://www.katherinealbrecht.com/>
- 67 | Philip Knightley, *The Second Oldest Profession: Spies and Spying in the Twentieth Century*, London: Andre Deutsch Ltd, 1986.
- 68 | Brett F. Woods, *Propaganda and the Fiction of William Le Queux*. See: <http://www.etext.org/Zines/Critique/article/lequeux.html>.
- 69 | See: http://news.bbc.co.uk/2/hi/uk_news/7036121.stm
- 70 | "The best one I found was Charles Cruickshank, Deception in World War II (Oxford: Oxford University Press, 1981). I should point out that wooden bombs really were used back then, for training". (<http://airminded.org/2005/11/01/levity-through-airpower/>)
 "I am currently carrying out historical research on an astonishing tale from World War II: the dropping (by joke) of wooden bombs by the Allies on dummy German airfields or on wooden dummy installations at authentic airfields. These tales can be found everywhere in France, Belgium, German, North Africa, Holland and Finland, etc. They are not rumours and some have been checked out and ruled genuine by reliable witnesses. Photographic proof exists and some of these wooden bombs (with ironic inscriptions sometimes like "wood for wood"...) can even be found in museums (as in Sainte-Mère l'Eglise). My research has shown that these facts concerned fighter-bombers and were not part of operations planned by military hierarchy, so they can only be initiatives taken by individual pilots with or without permission from the Squadron leader", and "(...) Even Donovan, the head of America's OSS, is said to have forwarded the following intelligence extract to President Roosevelt: "For months, Berlin has been camouflaging its streets, squares, parks and lakes to confuse Allied fliers", reported Donovan. "All of Unter der Linden is now covered with giant colored nets under which the traffic moves... A simulated village has been erected in the center of the lake, of painted canvas on thin laths. To show contempt for this German effort at camouflage, a single RAF plane flew over the 'village' last night and dropped one wooden bomb".
- 71 | "Just a few years after Baudelaire's death, Blanqui topped his career of as a conspirator by a memorable masterstroke. After the murder of Victor Noir, Blanqui tried to get an overview about his soldiery. It remains to be seen how much everyone knew him in his squad. He compounded himself with Granger, his adjutant, who gave the orders for a revue of the Blanquists. It is described by Geoffrey as follows: "He left the house armed, said goodbye to his sisters and took his station in the Champs-Élysées. Based on the arrangement with Granger there the standing down of the troops should take place, whose mysterious general was Blanqui. He knew the chiefs and now could see their soldiers behind each of them marching in step and in orderly formations. It happened as concluded. Blanqui gave his Revue without anyone noticing this strange spectacle. The old man, leant at a tree, stood in the crowd and among the people, who watched how he himself watched. Attentively he saw his friends coming near, how they mutely neared in a mumble intermitted by shouts". Excerpt from: Charles W. Benjamin, 'Baudelaire. Ein Lyriker im Zeitalter des Hochkapitalismus', (eds) Tiedemann, R., Schwepphenh user, H., *Walter Benjamin, Gesammelte Schriften I-2*, Frankfurt am Main: Suhrkamp Verlag, 1974, p. 604.
- 72 | Rebecca Solnit, *Wanderlust: A History of Walking*, London/New York: Verso, 2001, p.72. <http://www.gs1belu.org/>
- 73 | See: <https://mailman.waag.org/cgi-bin/mailman/listinfo/rfidnetwork>
- 74 | Waag Society is funded through the Ministry of Culture and Education, www.waag.org
- 75 | The project will be performed by TNO ICT Groningen, Moboubiq Amsterdam, the Koninklijke Academie voor Beeldende Kunsten (KABK) Den Haag, and de Waag Society Amsterdam, with advice from the University of Leiden and the Rathenau Institute.
- 76 | Jakob Dylan, 'Seeing Things' 2008, Something Good This Way Comes

Network Notebook 01

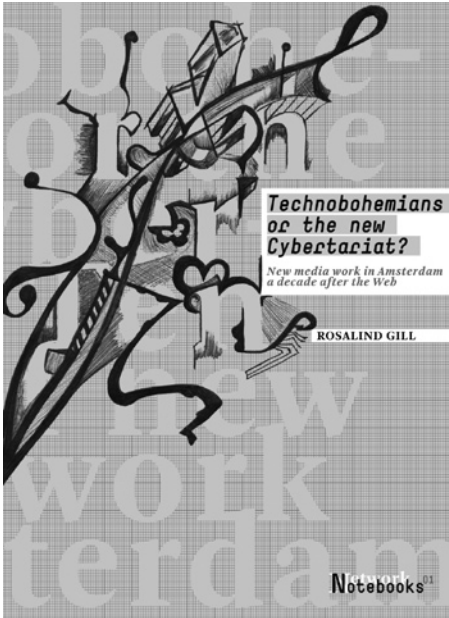

Rosalind Gill, *Technobohemians or the new Cybertariat? New media work in Amsterdam a decade after the Web*, Amsterdam: Institute of Network Cultures, 2007.

ISBN: 978-90-78146-02-5.

Order a free copy by emailing
info@networkcultures.org

Or download a pdf from
<http://www.networkcultures.org>

About the publication: Accounts of new media working conditions draw heavily on two polarised stereotypes, veering from techno-utopianism on the one hand, to a vision of webworkers as the new 'precariat', victims of neo-liberal economic policies on the other. Heralded from both perspectives as representing the brave new world of work, what is striking is the absence of research on new media workers' own experiences, particularly in a European context. This INC commissioned research goes beyond contemporary myths to explore how people working in the field experience the pleasures, pressures and challenges of working on the web. Illustrated throughout with quotations from interviews, it examines the different career paths emerging for content-producers in web-based industries, questions the relevance of existing education and training, and highlights the different ways in which people manage and negotiate freelancing, job insecurity, and keeping up to date in a fast-moving field where both software and expectations change rapidly.

The research is based on 35 interviews carried out in Amsterdam in 2005, and contextually draws upon a further 60 interviews with web designers in London and Brighton. The interviews were conducted by Danielle van Diemen and Rosalind Gill.

About the author: Rosalind Gill is a teacher and researcher based at the London School of Economics and Political Science. She is author of *The Gender-Technology Relation* (with Keith Grint) and *Gender and the Media* published by Polity Press. She conducted research on new media working conditions for the European Commission in 2000. She is preparing a book about women and the web and completing analysis of 180 interviews with web designers in London, Brighton and Los Angeles.

Colophon: Interviews: Rosalind Gill and Danielle van Diemen. Copy editing: Ned Rossiter. Design: Léon&Loes, Rotterdam. Network Notebooks editors: Geert Lovink and Sabine Niederer. Printing: Cito Repro, Amsterdam. Publisher: Institute of Network Cultures, Amsterdam

STUDIES IN NETWORK CULTURES

Studies in Network Cultures is a book series that investigates concepts and practices special to network cultures. Network cultures can be understood as social-technical formations under construction. They rapidly assemble, and can just as quickly disappear, creating a sense of spontaneity, transience and even uncertainty. How to conduct research within such a shifting environment is a key interest to this series. Studies in Network Cultures are edited by Geert Lovink, and published by NAI Publishers, Rotterdam and the Institute of Network Cultures in Amsterdam.



Animal Spirits:
A Bestiary of the Commons
by Matteo Pasquinelli.

Animal Spirits is a conceptual 'book of beasts', revealing the irrational forces at work behind the digital economy and cultural production. Against the disembodied theories of postmodernism, Pasquinelli finds in the 'animal body' a concrete ground to reverse the capitalist exploitation of collective imagery.
ISBN 978-90-5662-663-1
€19,50

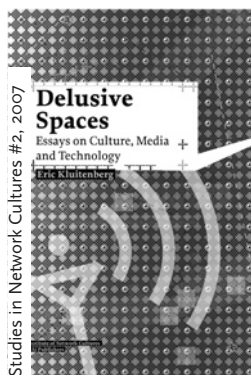

Delusive Spaces: Essays on Culture, Media and Technology
by Eric Kluitenberg.

With this book Kluitenberg insists upon a cultural reading of media and technology, and argues that in order to reach the desired critical position it is necessary to understand the much larger histories of the linkages of culture and technology and to situate 'new media' cultural practices carefully within the local contexts they emerged from.
ISBN 978-90-5662-617-4
€19,50

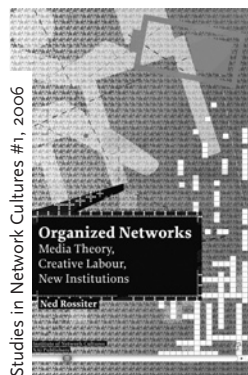

Organized Networks: Media Theory, Creative Labour, New Institutions
by Ned Rossiter.

The celebration of network cultures as open, decentralized, and horizontal all too easily forgets the political dimensions of labour and life in informational times. Organized Networks sets out to destroy these myths by tracking the antagonisms that lurk within Internet governance debates, the exploitation of labour in the creative industries, and the aesthetics of global finance capital.
ISBN 90-5662-526-8
€19,50

NAI Publishers

**Institute of
network cultures**

Studies in Network Cultures are available in bookstores worldwide and at www.naipublishers.com.
For more information, check www.networkcultures.org.

Cities across the world are about to enter the next phase of their development. A near invisible network of radio frequency identification tags (RFID) is being deployed on almost every type of consumer item. These tiny, traceable chips, which can be scanned wirelessly, are being produced in their billions and are capable of being connected to the internet in an instant.

This so-called 'Ambient intelligence' promises to create a global network of physical objects every bit as pervasive and ubiquitous as the worldwide web itself. Some are already calling this controversial network the 'internet of things', describing it as either the ultimate convenience in supply-chain management, or the ultimate tool in our future surveillance. This network has the power to reshape our cities and yet it is being built with little public knowledge or consent.

Here Rob van Kranenburg examines what impact RFID, and other systems, will have on our cities and our wider society; while also ruminating on what alternative network technologies could help safeguard our privacy and empower citizens to take power back into their own hands. It is both a timely warning and a call to arms.

Rob van Kranenburg (1964) has been teaching at various schools in the Netherlands (UvA, EMMA Interaction Design, Industrial Design) and has worked at several Dutch cultural institutions; de Balie, Doors of Perception and Virtual Platform. Currently he works as the Head of the Public Domain Program at Waag Society. He lives in Ghent, Belgium.

Amsterdam, The Netherlands, 2008.

ISBN/EAN 978-90-78146-06-3

**institute of
network cultures**



Waag Society

Hogeschool van Amsterdam
University of Applied Sciences